



# SECURE TRANSPORT SYSTEMS

---

## PRODUCT CATALOG



---

THE KEY TO SECURITY





## From our family, to yours, thank you for your interest in American Aluminum Accessories, LLC.

We manufacture a wide variety of products from high-quality toolboxes to an extensive line of products designed to meet the ever-changing needs of the Law Enforcement Community.

In 1989, we began as a manufacturer of our superior quality CamLocker toolboxes. In 1992, due to the demand for safe, secure canine transport for nearby Law Enforcement Departments, we introduced the very first in-vehicle EZ Rider K-9 Container.

We have continuously grown and expanded our products, catering to the needs and wants of our valued customers and high profile clientele.

Over the years as your needs have changed, we have evolved and expanded our products to include Inmate Transport Systems, Vault Systems, K-9 Training Aids, Contraband Containment and Animal Control Systems.

We strive daily to manufacture the finest products available and we always welcome the input you provide to continue our improvements. We would like to thank each and every one of our valued customers. It is with our deepest appreciation we thank you, the Law Enforcement Community for your dedication and service.



In 2024, we joined the **Team Gamber-Johnson** family, allowing us to continue to grow in our commitment to rugged, safety-focused innovation and U.S. manufacturing quality.

# TABLE OF CONTENTS



## EZ K9 SOLUTIONS

- Handlers Choice ..... 2
- Platform Systems ..... 4
  - K9 Unit: Make & Model Fit Guide ..... 7
- EZ Removable Divider ..... 10
- Block Out Kit ..... 12
- Powder Coats ..... 12
- Wings ..... 13
- Additional Accessories ..... 14
- K9 Electronics ..... 15
- EZ AC Adapter Systems ..... 16
- CoolGuard Plus M910 Series Guide ..... 18
- CoolGuard 360 Mobile App ..... 22
- K9 + Blac-Rac: K9 Weapon Storage Solution ..... 24
- EZ Rider Universal Options ..... 26
- Collapsible & Standard Crates ..... 28
- Home Kennel ..... 30
- Testimonials ..... 31



## VAULT SYSTEMS

- Designed for Law Enforcement ..... 33
- AAA UP Vault ..... 34
- Vault Variations ..... 35
- SUV Universal Vault Setups ..... 36
- Vault Product Selection ..... 36



## INMATE TRANSPORT SOLUTIONS

- Standard & Extended Van ..... 39
- IT Unit: Make & Model Fit Guide ..... 40
- SWAT Van ..... 41
- Other Features ..... 42
- Screen Systems ..... 43



## ANIMAL CONTROL

- In Van Animal Control Units ..... 45
- Truck Slide-In Animal Control Units ..... 45
- Animal Control Product Selection ..... 47
- Jumps, Obstacles, and Military Course ..... 48



## CAMLOCKER TOOLBOXES

- CamLocker Section Table of Contents ..... 51
- CamLocker Exclusive Features ..... 52
- Crossover Truck Toolbox ..... 54
  - How to Measure CamLocker Toolboxes ..... 54
  - Crossover Truck Toolbox Variations ..... 55
  - Standard/Classic ..... 56
  - Slimline & King Slimline ..... 60
  - King Size ..... 62
  - Deep & Tall ..... 66
  - King Size Xtra Deep & Tall ..... 67
  - CamLocker HD ..... 68
  - Recreational Vehicle (RV) Box ..... 70
  - Sidemount Boxes ..... 72
  - SxS (UTV) Boxes ..... 74
  - Side Mount & Underbody Boxes ..... 76
  - Hunting Accessories ..... 77
  - CamLocker Crossover: Make & Model Fit Guide ..... 78



- AAA Contact Info ..... 80
- AAA Employee Directory ..... 81



**Customer Care Center:** Toll Free 1-800-277-0869 | Monday through Friday, 8:00 am to 4:30 pm  
**Customer Service, Purchasing, or quote Assistance on All Products:** 1-800-277-0869

[WWW.EZRIDERONLINE.COM](http://WWW.EZRIDERONLINE.COM)



DODGE CHARGER



## HANDLER'S CHOICE

From the inception of K-9 transport, American Aluminum has taken input from Officers in the design and function of the various platforms. From the standard window and door panels to the RESCUE and COOLGUARD PLUS created to keep their K-9 partners safe, Officers from around the country have helped refine the platforms to add safety, and performance to the product.

The utility of small department vehicles was enhanced when we were asked to make a unit for the K-9 officer and an inmate, the 1/3-2/3 unit was

created. We value the safety and security of the officers using our K-9 inserts as well as comments and suggestions for design modifications.

We would like to thank and honor those in the field of law enforcement for their contributions and their dedication to serve and protect. Our over 30 year relationship with the K-9 community has made the American Aluminum K-9 Platform systems the Handlers Choice.



FORD PIU

## OUR ATTENTION TO DETAIL MAXIMIZES YOUR K-9 SPACE

The Original E/Z Rider K9 Platform unit is fully contoured for a vehicle specific fit. The K9 Insert is made of .125 mill finish aluminum, with a .080 lid and .063 door panels.

The unit is fully welded with vertical front bars for added strength and area window for easy cleaning.

Seamless Base Pan fully welded and specific fit contouring to allow canine leg safe ease upon entry and exit. Base extends door sill to door sill utilizing all available space and allowing for easy rinsing and cleaning without damage to vehicle. Vented top's allows for maximum airflow from vehicles with existing factory rear A/C and heat. All platform units include perfectly contoured Aluminum Window Guards and Aluminum Door Panels. Window Guards are powder coated black. Door Panels are contoured, smooth, flat design for ease of install. Complete Hardware kit with installation instructions included.

## PLATFORM SYSTEMS: TESTED TO ENSURE OUTSTANDING DURABILITY & PERFORMANCE

Powder coat tested for 1000 hour salt fog chamber test per ASTM.

**Powder coat process was rated excellent.**

Our EZ Rider Platform System (performed on a F150 truck and Ford Interceptor SUV) tested for roof mounted airbag deployment compatibility and **our system was rated excellent.**

Test performed by Karco Engineering. Sedan models weight 225 lbs. and SUV models weight 325 lbs.



2015-2020 CHEVY TAHOE



2021- CURRENT CHEVY TAHOE

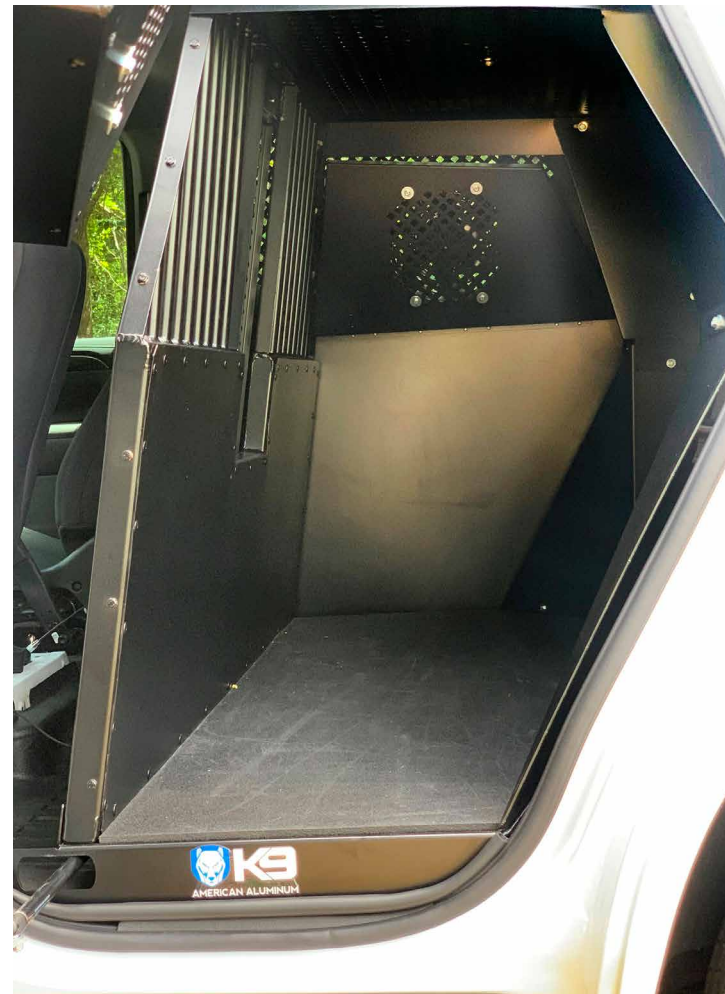

## EZ K9 PLATFORM WITH 1/3 STORAGE

The storage portion of the unit was designed for trucks and suvs to assist handlers in their ever growing need for secure storage.

### FEATURES

- The shelving unit utilizes all the safety features of our fully welded front panels with vertical bars.
- Three tiers of shelving
- Each shelf comes standard with raised front perforated edges to allow secure tie down locations.
- All shelves are built from .125 Mill Finish aluminum for added strength.
- Available with a Cam locking Vault drawer (18"X18"X6") for an added level of secure storage. (Optional)
- Vehicles available- Ford F250/350, Dodge Crew cab, Ford Explorer, Chevy Tahoe ( see chart on page 5)

2020 ISUV



# EZ GLIDER DOOR

This is a redesign of our EZ Rider K9 Platform Units Emergency Exit Door.

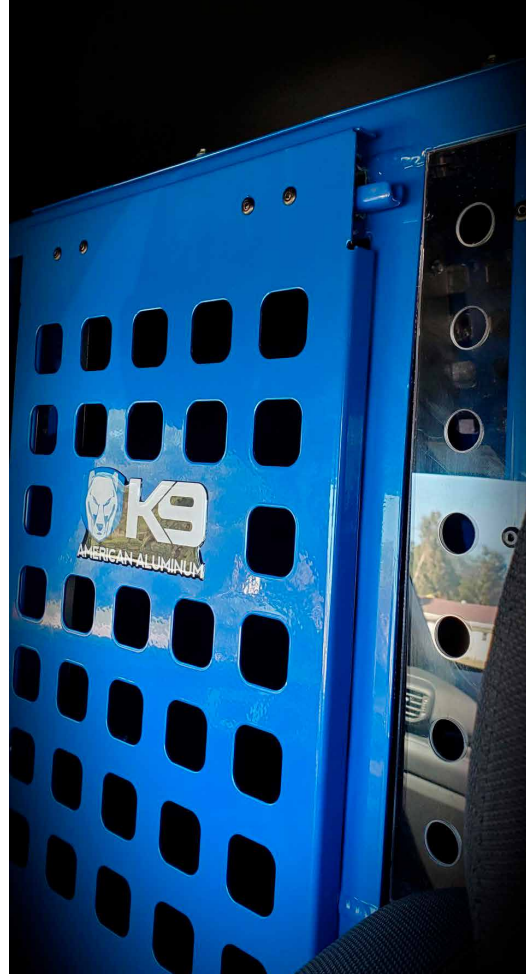
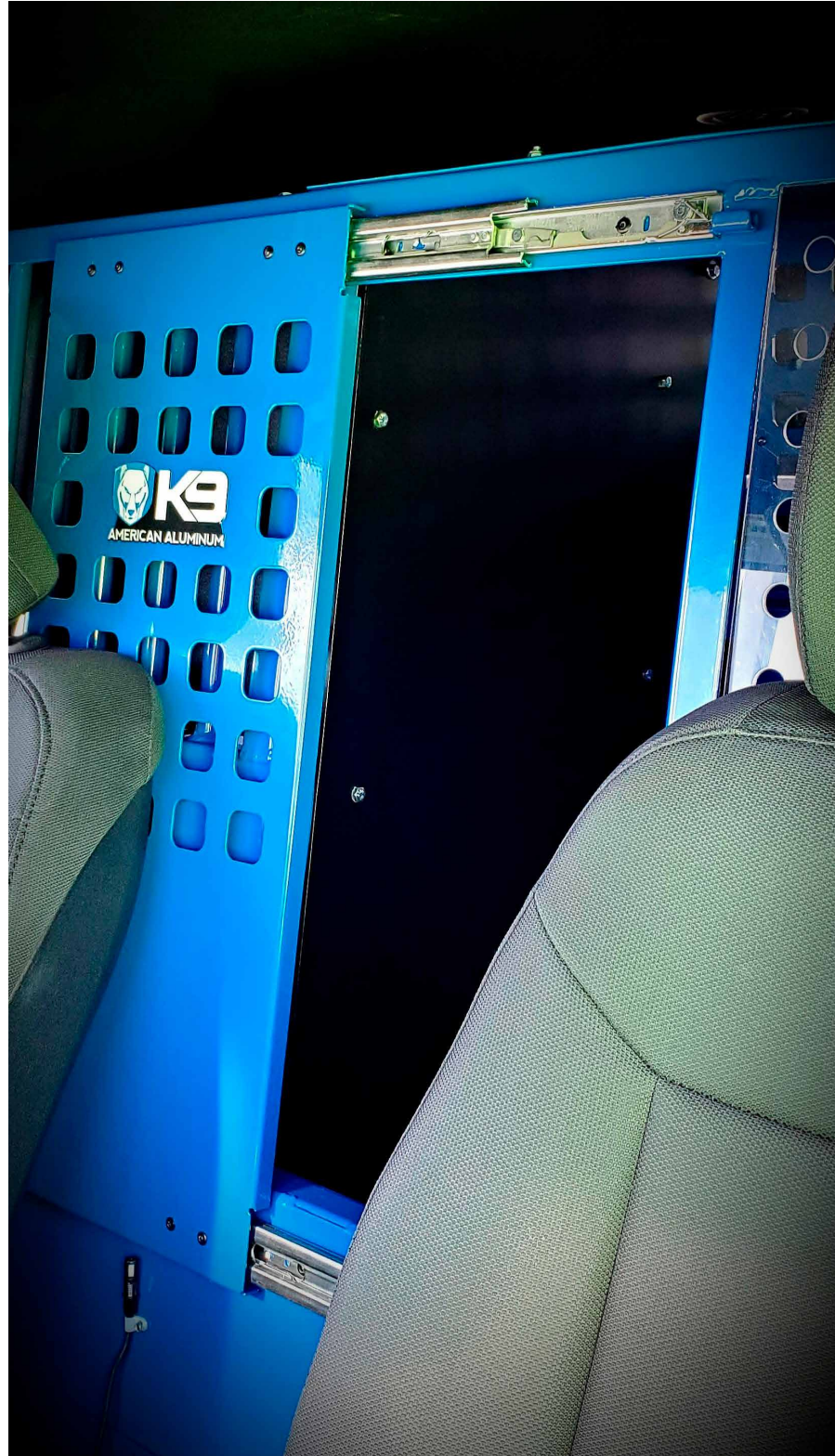

### FEATURES

- Slim design - over an inch thinner than the previous door.
- Equipped with Heavy Duty ball bearing slides for a smooth and QUIET action.
- Spring loaded Easy Touch overhead latch for quick release and a Bump Stop to ensure the door doesn't lock in the open position.

# K9 UNIT: MAKE & MODEL FIT GUIDE

VEHICLE	K9 PLATFORM	K9 PLAT W/ SHELVING	K9 PLAT W/ RAMP	K9 PLAT W/ RAMP & SHELVING	EXTENDED K9 PLAT	K9 1/3 2/3	K9 1/3 2/3 REVERSE	EXTENDED 1/3 2/3 K9
Ford Explorer 2020-2026	✓	✓			✓	✓	✓	
Ford Explorer 2011-2019	✓				✓	✓		✓
Ford Expedition 2018-2024	✓				✓			✓
Ford Expedition 2025-2026	✓				✓	✓		
Ford F150 2015-2026	✓	✓	✓			✓		
Ford F250/350 2017-2024	✓	✓	✓	✓		✓		
Chevy EV Blazer 2025-2026	✓							
Chevy Tahoe 2021-2026	✓	✓			✓	✓		
Chevy Tahoe 2015-2020	✓	✓			✓			✓
Chevy Crew Cab 2014-2018	✓	✓	✓			✓		
Chevy Crew Cab 2019-2026	✓	✓	✓			✓		
Chevy Suburban 2015-2020	✓				✓	✓		
Chevy Suburban 2021-2024	✓					✓		
Dodge Charger 2011-2024	✓							
Dodge Durango 2011-2026	✓					✓		
Dodge Crew Cab 2019-2024	✓	✓					✓	
Dodge Crew Cab 2015-2018	✓					✓		
Toyota Tundra 2025-2026	✓		✓					

FULL K9 PLATFORM



1/3 PRISONER, 2/3 K9

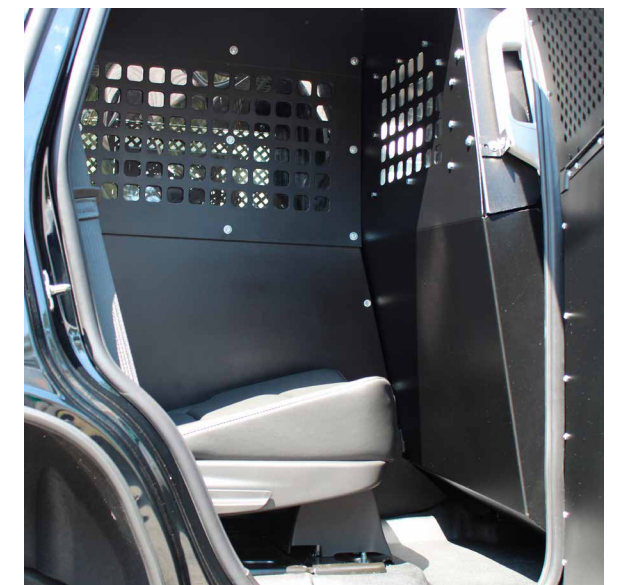

## TAHOE DESIGN FEATURES

### FAN GUARD

Designed to give ample room for the massive side curtain airbag to drop unimpeded while also protecting the vehicle OEM trim from a high energy K9.

As an added feature it **gives the fan a slight downward angle to have a greater cooling effect on the K9** as to not blow straight across over the top of the K9's back.

### ELECTRONIC K9 PROTECTION

- Due to the design of the lower pan mounting brackets there is no guessing with pan placement. It can only go in one position.
- The unit comes with horizontal bubble trim for the lower pan and rear partition edge and the door opening. This is an added protection for clean out as well as a superb finish.



- Designed to easily accessorize with the K9 Cool Guard Plus system with rescue.
- The pan has a pass through cutout for the Cool Guard gas strut as well as having pre punched mounting points for the gas strut brackets on the door panels and lower pan bracket. **This gives precise mounting every time.**
- Designed with comfort and ease of access in mind. The front partition was moved to allow **full track back for the driver and the passenger.**
- While the officer has an exceptional amount of room, **kennel space for the K9 was not sacrificed.** The kennel measures 65.75" passenger to driver and 35.5" front to rear.
- The floor pan brackets are constructed of 11ga cold rolled steel. **The brackets mount directly to the passenger and driver side rear seat mounts** with points of contact at both front and rear of pan.
- The unit is also equipped with 2 upper brackets also constructed of cold rolled steel **giving 6 mounting points**
- The unit was designed with a straight rear partition to not protrude into the rear of the vehicle **allowing a wide range of rear cargo storage option.**

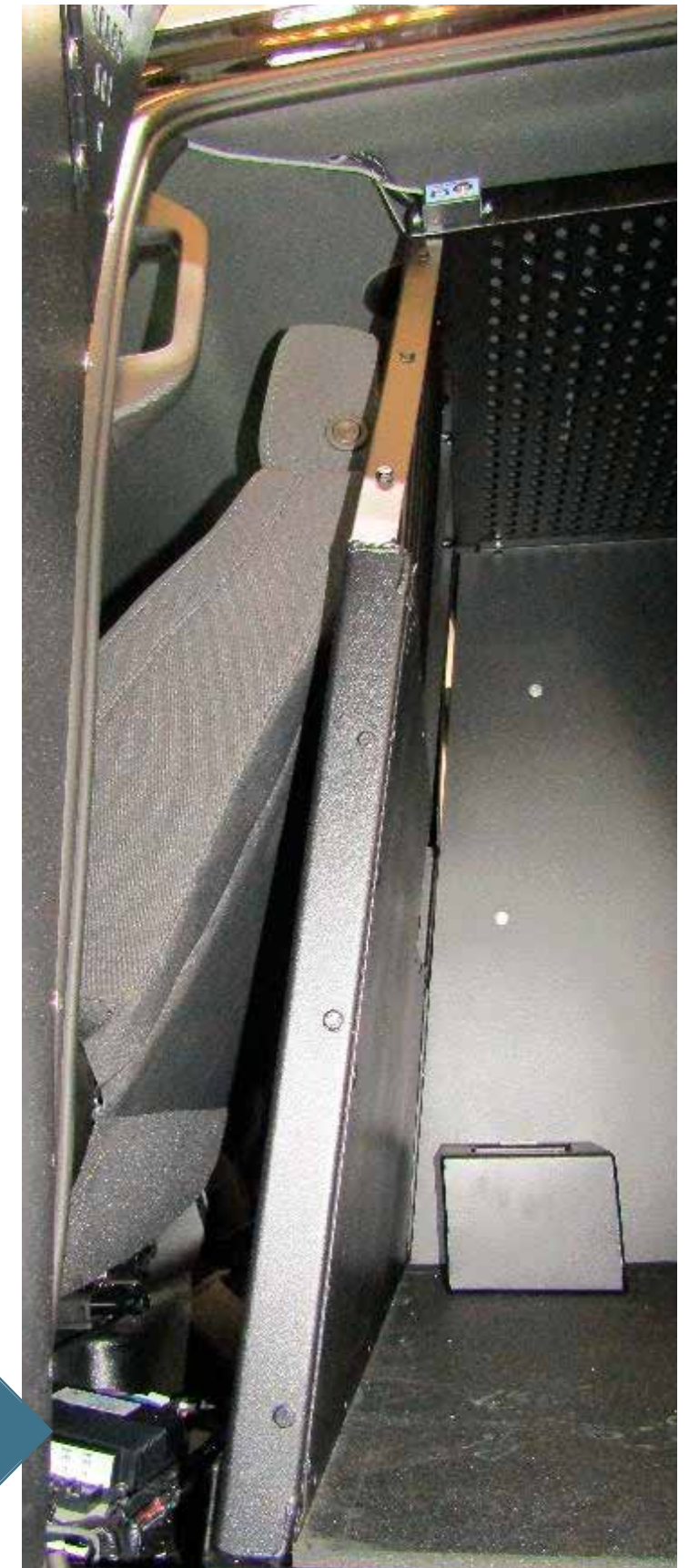

# E/Z REMOVABLE DIVIDER

Our E/Z Divider allows you to convert your existing platform unit into a dual canine transport containment system. The divider is removable and fully adjustable. Constructed of aluminum with a center door and sliding latch to allow access to the other side of the cage.



## DIVIDER OPTIONS\*

\*arrows indicate K9 Exit direction

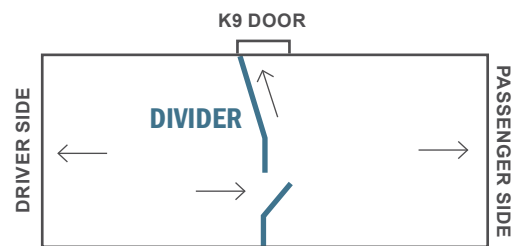

**DEP-001** Passenger Side Exit Extended Units

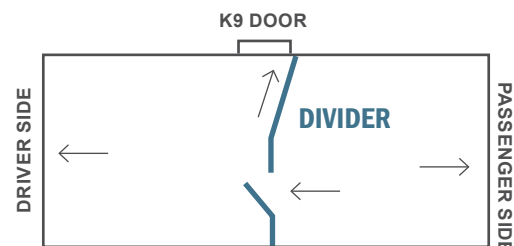

**DED-002** Driver Side Exit Extended Units

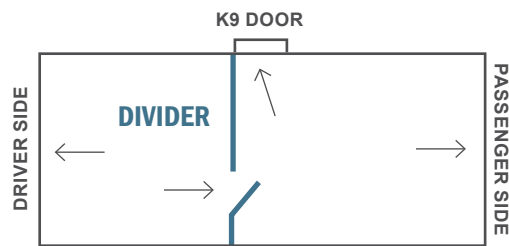

**DP-003** Passenger Side Exit Standard Units

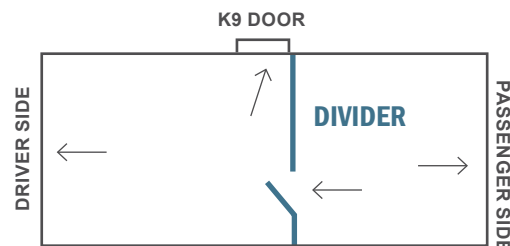

**DD-004** Driver Side Exit Standard Units

DODGE DIVIDERS	
PRODUCT NUMBER	DESCRIPTION
SA-10338	DIVIDER - 003 - 11-CURRENT DURANGO PF
SA-10339	DIVIDER - 003 - 14-18 DODGE CREW CAB PF
SA-10340	DIVIDER - 003 - 19-CURRENT DODGE CREW CAB PF
SA-10353	DIVIDER - 004 - 11-CURRENT DURANGO PF
SA-10354	DIVIDER - 004 - 14-18 DODGE CREW CAB PF
SA-10355	DIVIDER - 004 - 19-CURRENT DODGE CREW CAB PF
SA-10376	DIVIDER - SOLID 003 - 11-CURRENT DURANGO PF
SA-10377	DIVIDER - SOLID 003 - 14-18 DODGE CREW CAB PF
SA-10378	DIVIDER - SOLID 003 - 19-CURRENT DODGE CREW CAB PF
SA-10391	DIVIDER - SOLID 004 - 11-CURRENT DURANGO PF
SA-10392	DIVIDER - SOLID 004 - 14-18 DODGE CREW CAB PF
SA-10393	DIVIDER - SOLID 004 - 19-CURRENT DODGE CREW CAB PF

FORD EXPIDITION DIVIDERS	
PRODUCT NUMBER	DESCRIPTION
SA-10333	DIVIDER - 003 - 07-17 EXPEDITION PF
SA-10348	DIVIDER - 004 - 07-17 EXPEDITION PF
SA-10371	DIVIDER - SOLID 003 - 07-17 EXPEDITION PF
SA-10386	DIVIDER - SOLID 004 - 07-17 EXPEDITION PF
SA-10334	DIVIDER - 003 - 18-24 EXPEDITION PF
SA-10349	DIVIDER - 004 - 18-24 EXPEDITION PF
SA-10372	DIVIDER - SOLID 003 - 18-24 EXPEDITION PF
SA-10387	DIVIDER - SOLID 004 - 18-24 EXPEDITION PF

FORD F-150 DIVIDERS	
PRODUCT NUMBER	DESCRIPTION
SA-10330	DIVIDER - 003 - 09-14 F150 PF
SA-10345	DIVIDER - 004 - 09-14 F150 PF
SA-10368	DIVIDER - SOLID 003 - 09-14 F150 PF
SA-10383	DIVIDER - SOLID 004 - 09-14 F150 PF
SA-10331	DIVIDER - 003 - 15-20 F150 PF
SA-10346	DIVIDER - 004 - 15-20 F150 PF
SA-10369	DIVIDER - SOLID 003 - 15-20 F150 PF
SA-10384	DIVIDER - SOLID 004 - 15-20 F150 PF
SA-10396	DIVIDER - RAMP 003 - 15-20 F150 PF
SA-10400	DIVIDER - RAMP 004 - 15-20 F150 PF
SA-10404	DIVIDER - RAMP SOLID 003 - 15-20 F150 PF
SA-10408	DIVIDER - RAMP SOLID 004 - 15-20 F150 PF
SA-10410	DIVIDER - INVERTED 003 - 15-20 F150 PF
SA-10412	DIVIDER - INVERTED 004 - 15-20 F150 PF
SA-10414	DIVIDER - INVERTED SOLID 003 - 15-20 F150 PF
SA-10416	DIVIDER - INVERTED SOLID 004 - 15-20 F150 PF
SA-10332	DIVIDER - 003 - 21-CURRENT F150 PF
SA-10347	DIVIDER - 004 - 21-CURRENT F150 PF
SA-10370	DIVIDER - SOLID 003 - 21-CURRENT F150 PF
SA-10385	DIVIDER - SOLID 004 - 21-CURRENT F150 PF
SA-10397	DIVIDER - RAMP 003 - 21-CURRENT F150 PF
SA-10401	DIVIDER - RAMP 004 - 21-CURRENT F150 PF
SA-10405	DIVIDER - RAMP SOLID 003 - 21-CURRENT F150 PF
SA-10409	DIVIDER - RAMP SOLID 004 - 21-CURRENT F150 PF
SA-10411	DIVIDER - INVERTED 003 - 21-CURRENT F150 PF
SA-10413	DIVIDER - INVERTED 004 - 21-CURRENT F150 PF
SA-10415	DIVIDER - INVERTED SOLID 003 - 21-CURRENT F150 PF
SA-10417	DIVIDER - INVERTED SOLID 004 - 21-CURRENT F150 PF

FORD EXPLORER DIVIDERS	
PRODUCT NUMBER	DESCRIPTION
SA-10318	DIVIDER - 001 EXTENDED - 11-19 ISUV PF
SA-10322	DIVIDER - 002 EXTENDED - 11-19 ISUV PF
SA-10326	DIVIDER - 003 - 11-19 ISUV PF
SA-10341	DIVIDER - 004 - 11-19 ISUV PF
SA-10356	DIVIDER - SOLID 001 - 11-19 ISUV PF
SA-10360	DIVIDER - SOLID 002 - 11-19 ISUV PF
SA-10364	DIVIDER - SOLID 003 - 11-19 ISUV PF
SA-10379	DIVIDER - SOLID 004 - 11-19 ISUV PF
SA-10319	DIVIDER - 001 EXTENDED - 20-CURRENT ISUV PF
SA-10323	DIVIDER - 002 EXTENDED - 20-CURRENT ISUV PF
SA-10327	DIVIDER - 003 - 20-CURRENT ISUV PF
SA-10342	DIVIDER - 004 - 20-CURRENT ISUV PF
SA-10357	DIVIDER - SOLID 001 - 20-CURRENT ISUV PF
SA-10361	DIVIDER - SOLID 002 - 20-CURRENT ISUV PF
SA-10365	DIVIDER - SOLID 003 - 20-CURRENT ISUV PF
SA-10380	DIVIDER - SOLID 004 - 20-CURRENT ISUV PF

CHEVY TAHOE DIVIDERS	
PRODUCT NUMBER	DESCRIPTION
SA-10320	DIVIDER - 001 EXTENDED - 15-20 TAHOE
SA-10324	DIVIDER - 002 EXTENDED - 15-20 TAHOE
SA-10328	DIVIDER - 003 - 15-20 TAHOE
SA-10343	DIVIDER - 004 - 15-20 TAHOE
SA-10358	DIVIDER - SOLID 001 - 15-20 TAHOE
SA-10362	DIVIDER - SOLID 002 - 15-20 TAHOE
SA-10366	DIVIDER - SOLID 003 - 15-20 TAHOE
SA-10381	DIVIDER - SOLID 004 - 15-20 TAHOE
SA-10321	DIVIDER - 001 EXTENDED - 21-CURRENT TAHOE
SA-10325	DIVIDER - 002 EXTENDED - 21-CURRENT TAHOE
SA-10329	DIVIDER - 003 - 21-CURRENT TAHOE
SA-10344	DIVIDER - 004 - 21-CURRENT TAHOE
SA-10359	DIVIDER - SOLID 001 - 21-CURRENT TAHOE
SA-10363	DIVIDER - SOLID 002 - 21-CURRENT TAHOE
SA-10367	DIVIDER - SOLID 003 - 21-CURRENT TAHOE
SA-10382	DIVIDER - SOLID 004 - 21-CURRENT TAHOE

CHEVY CREW CAB DIVIDERS	
PRODUCT NUMBER	DESCRIPTION
SA-10335	DIVIDER - 003 - 14-18 CHEVY CREW CAB
SA-10350	DIVIDER - 004 - 14-18 CHEVY CREW CAB
SA-10373	DIVIDER - SOLID 003 - 14-18 CHEVY CREW CAB
SA-10388	DIVIDER - SOLID 004 - 14-18 CHEVY CREW CAB
SA-10336	DIVIDER - 003 - 19-22 CHEVY CREW CAB PF
SA-10351	DIVIDER - 004 - 19-22 CHEVY CREW CAB PF
SA-10374	DIVIDER - SOLID 003 - 19-22 CHEVY CREW CAB PF
SA-10389	DIVIDER - SOLID 004 - 19-22 CHEVY CREW CAB PF
SA-10394	DIVIDER - RAMP 003 - 19-22 CHEVY CREW CAB PF
SA-10398	DIVIDER - RAMP 004 - 19-22 CHEVY CREW CAB PF
SA-10402	DIVIDER - RAMP SOLID 003 - 19-22 CHEVY CREW CAB PF
SA-10406	DIVIDER - RAMP SOLID 004 - 19-22 CHEVY CREW CAB PF
SA-10337	DIVIDER - 003 - 23-CURRENT CHEVY CREW CAB PF
SA-10352	DIVIDER - 004 - 23-CURRENT CHEVY CREW CAB PF
SA-10375	DIVIDER - SOLID 003 - 23-CURRENT CHEVY CREW CAB PF
SA-10390	DIVIDER - SOLID 004 - 23-CURRENT CHEVY CREW CAB PF
SA-10395	DIVIDER - RAMP 003 - 23-CURRENT CHEVY CREW CAB PF
SA-10399	DIVIDER - RAMP 004 - 23-CURRENT CHEVY CREW CAB PF
SA-10403	DIVIDER - RAMP SOLID 003 - 23-CURRENT CHEVY CREW CAB PF
SA-10407	DIVIDER - RAMP SOLID 004 - 23-CURRENT CHEVY CREW CAB PF



## BLOCK OUT KIT

Our block out kits are made from high quality 1/8th inch thick polycarbonate with optional 3/4 inch round holes or 1.5 in square holes with radius corners. The block out kit is a great way to decrease the spread of K9 hair throughout your vehicle while still allowing air flow. We offer the block out as a set for front and rear or they can be purchased independently.

BLOCK OUT KITS	
PRODUCT NUMBER	DESCRIPTION
K901166	2021-CURRENT CHEVY TAHOE PF-21 TAHOE FRONT BLOCK OUT
K901167	2021-CURRENT CHEVY TAHOE PF-21 REAR TAHOE BLOCK OUT
K901170	2021-CURRENT CHEVY TAHOE PF EXT-21 TAHOE FRONT BLOCK OUT
K901171	2021-CURRENT CHEVY TAHOE PF EXT-21 TAHOE REAR BLOCK OUT
K901670	2015 F150 BACK WINDOW BLOCK OUT LEXAN
K901671	2015 F150 FRONT BLOCK OUT LEXAN PF/IK
K901672	2015 F150 PRIS BACK WINDOW BLOCK OUT LEXAN
K901673	TUNDRA FRONT BLOCK OUT LEXAN
K901674	TUNDRA REAR BLOCK OUT LEXAN
K901675	2019 DODGE CREW CAB FRONT BLOCK OUT LEXAN
K901676	2019 DODGE CREW CAB BACK WINDOW BLOCK OUT LEXAN
K901677	2018 EXPEDITION BACK WINDOW BLOCK OUT LEXAN
K901678	2018 EXPEDITION FRONT BLOCK OUT LEXAN
K901679	2015 TAHOE BACK WINDOW BLOCK OUT LEXAN
K901680	2015 TAHOE FRONT BLOCK OUT LEXAN

## WINGS

All polycarbonate pieces, including front and rear polycarbonate wings and headliner covers as well as block out kits, are also offered in aluminum. For handlers with high energy K9's that have a tendency to chew, this is a great option. Systems are airbag tested. Please call for details.

### ALUMINUM WINGS OPTIONAL (\$+)



### POLYCARBONATE WINGS STANDARD



K9 WINGS	
PRODUCT NUMBER	DESCRIPTION
K900039	2017-CURRENT CHARGER PF K9 FRONT LEXAN DRIVER SIDE
K900040	2017-CURRENT CHARGER PF K9 FRONT LEXAN PASSENGER SIDE
K900047	2017-CURRENT CHARGER PF K9 HEADLINER LEXAN
K900054	2017-CURRENT CHARGER PF K9 REAR LEXAN DRIVER SIDE
K900055	2017-CURRENT CHARGER PF K9 REAR LEXAN WING PASSENGER SIDE
K900064	2019-2022 CHEVY CREW CAB PF K9 FRONT LEXAN DRIVER SIDE
K900065	2019-2022 CHEVY CREW CAB PF K9 FRONT LEXAN PASSENGER SIDE
K900070	2019-2022 CHEVY CREW CAB PF K9 REAR LEXAN DRIVER SIDE
K900071	2019-2022 CHEVY CREW CAB PF K9 REAR LEXAN PASSENGER SIDE
K900083	2023-CURRENT CHEVY CREW CAB PF K9 FRONT LEXAN DRIVER SIDE
K900086	2023-CURRENT CHEVY CREW CAB PF K9 HEADLINER LEXAN
K900089	2023-CURRENT CHEVY CREW CAB PF K9 REAR LEXAN PASSENGER SIDE
K900090	2023-CURRENT CHEVY CREW CAB PF K9 REAR LEXAN DRIVER SIDE
K900107	2012-CURRENT DURANGO PF K9 FRONT LEXAN DRIVER SIDE
K900108	2012-CURRENT DURANGO PF K9 FRONT LEXAN PASSENGER SIDE
K900110	2012-CURRENT DURANGO PF K9 HEADLINER LEXAN PASSENGER SIDE
K900111	2012-CURRENT DURANGO PF K9 HEADLINER LEXAN DRIVER SIDE
K900117	2012-CURRENT DURANGO PF K9 REAR WING LEXAN DRIVER SIDE
K900118	2012-CURRENT DURANGO PF K9 REAR WING LEXAN PASSENGER SIDE
K900140	21-CURRENT F150 PF K9 FRONT LEXAN
K900155	2020-CURRENT ISUV PF K9 FRONT LEXAN DRIVER SIDE
K900156	2020-CURRENT ISUV PF K9 FRONT LEXAN PASSENGER SIDE
K900159	2020-CURRENT ISUV PF K9 REAR LEXAN DRIVER SIDE
K900160	2020-CURRENT ISUV PF K9 REAR LEXAN PASSENGER SIDE
K900216	2012-CURRENT DURANGO IK K9 LEXAN FRONT WING
K900226	2012-CURRENT DURANGO IK K9 LEXAN REAR WING
K900235	2012-CURRENT DURANGO IK K9 LEXAN HEADLINER
K900242	2018-CURRENT EXPEDITION IK K9 FRONT LEXAN WING DRIVER SIDE
K900243	2018-CURRENT EXPEDITION IK K9 LEXAN HEADLINER
K900262	2018-CURRENT EXPEDITION IK K9 REAR LEXAN TOP WING
K900289	2023-CURRENT CHEVY CREW CAB IK K9 HEADLINER LEXAN
K900294	2023-CURRENT CHEVY CREW CAB IK K9 FRONT LEXAN
K900298	2023-CURRENT CHEVY CREW CAB IK K9 REAR LEXAN
K900342	2020-CURRENT ISUV IK FRONT LEXAN DRIVER SIDE
K900345	2020-CURRENT ISUV IK K9 REAR LEXAN DRIVER SIDE
K900676	2011-2019 EXPLORER/ISUV PF K9 BACK DRIVER SIDE LEXAN
K900677	2011-2019 EXPLORER/ISUV PF K9 BACK PASSENGER SIDE LEXAN
K900679	2011-2019 EXPLORER/ISUV PF K9 FRONT PASSENGER LEXAN 8216
K900680	2011-2019 EXPLORER/ISUV PF K9 CANOPY LID LEXAN
K900707	2015-2020 TAHOE DRIVER REAR LEXAN
K900708	2015-2020 TAHOE PASSENGER REAR LEXAN
K900709	2015-2020 TAHOE FRONT LEXAN
K900741	2015-2020 TAHOE IK SIDE LEXAN
K900742	2015-2020 TAHOE IK PRIS SIDE LEXAN
K900743	2015-2020 TAHOE IK FRONT WING LEXAN
K900744	2015-2020 TAHOE IK FRONT BAR LEXAN
K900775	2014-2018 CHEVY CREW CAB FRONT WING LEXAN
K900803	2004-2018 DODGE CREW CAB REAR LEXAN WING
K900804	2004-2018 DODGE CREW CAB FRONT LEXAN WING
K901010	2004-18 DODGE CREW CAB IK SIDE LEXAN
K901059	2017 F250-350 PF FRONT WING LEXAN
K901101	2025 EXPEDITION MAX PF FRONT DRIVER LEXAN
K901102	2025 EXPEDITION MAX PF FRONT PASSENGER LEXAN

### TELE GREY OPTIONAL (\$+)

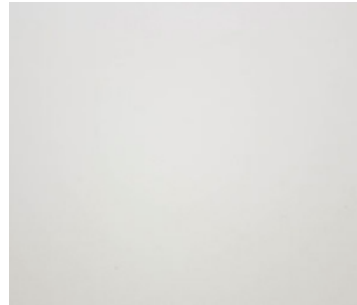

### TEX BLACK STANDARD



## POWDER COATS

AAA is a 100% manufacturer. We start with sheets of high quality aluminum and when we are done you have a finished product. We offer a full powder coat service. Our standard color for K9 units is Tex Black this color helps reduce silhouetting of the K9 in the vehicle.

POWDER COAT OPTIONS	
PRODUCT NUMBER	DESCRIPTION
XXX-0	None
XXX-1	Textured/Matte Black
XXX-2	Gloss Black
XXX-3	Tele gray
XXX-4	Battleship Gray
XXX-5	White
XXX-8	CUSTOM COLOR COMBINATION
XXX-10	GAMBER BLUE
XXX-9	CUSTOM COLOR
XXX-7	COBALT BLUE

## ADDITIONAL ACCESSORIES



### E/Z SPILL PROOF WATER DISH

PRODUCT NUMBER: AA-K9-99-034-0

A must for your K9 Transport system, our E/Z spill proof water dish is the perfect accessory to any and all of our K9 transport systems. Constructed of mill finish aluminum with 1 gallon water capacity. Our spill proof water dish comes with a easily removable mounting system.



### E/Z RUBBER MAT (INCLUDED WITH K9 INSERT)

PRODUCT NUMBER: SA-10747

The E/Z Rubber Mat is a bare bones necessity for any and all of our K9 transport systems. Heavy duty 1/8" thick for maximum durability and custom fit to your specific E/Z Rider Transport model, it provides a safe, comfy barrier for your canine from the aluminum platform base.



## K9 ELECTRONICS

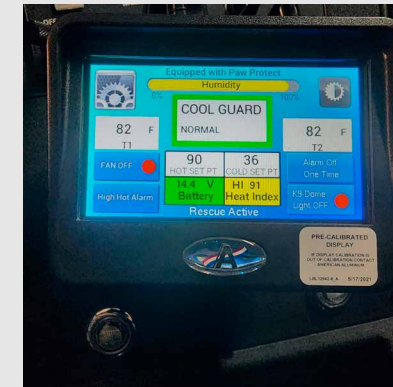

### COOL GUARD PLUS SERIES

PRODUCT NUMBER: AA-K9-04-008

Protect your department's investment in your canine partner or animal control unit with our in-vehicle CoolGuard Plus (or CGP). Our CoolGuard Plus gives you peace of mind and will self-activate to rapidly cool your canine when dangerous temperatures are detected inside the vehicle. The lethal temperature for an average size Law Enforcement K-9 is 103 to 107 degrees Fahrenheit for approximately 5 minutes.

#### COMES COMPLETE WITH:

- Display monitor
- Two temperature sensors with humidity for heat and cold
- A cool temperature setting for temperatures colder than 30 degrees Fahrenheit
- Automatic dual window drop
- High speed fan with dual fan option
- Fan guard and wiring harness
- Digital display for reading the vehicle temperature
- A unique horn alarm pattern
- Heat index and humidity display
- Self-diagnosing alerts with logs
- An equipment test
- Drive disable so the alarm will not go off while driving
- Alarm lights active- two outputs for flashing any lights connected on the vehicle (flashing lights not included)
- Low battery page function
- Paw Protect to remind the handler to not forget the K9 before leaving the vehicle
- Installation instructions and free technical support are included
- Full 1 year warranty against any defects



### E/Z COOLGUARD PAGER

PRODUCT NUMBER: SA-10459

Sold separately as an additional option for our E/Z CoolGuard, the Pager ensures that should you be outside of hearing range for the horn alarm, you will be notified by a page that your CoolGuard system has been activated. Installation instructions and free technical support are included. Full 1 year warranty against any defects.



### E/Z R.E.S.C.U.E. REMOTE DOOR OPENING SYSTEM

PRODUCT NUMBER: SA-10458

The E/Z Rescue Remote Door Opening System allows the officer to unlock, open and release the K-9 via remote transmitter. Should the officer be outside of the patrol car and need immediate assistance, his K-9 partner is a push of a button away. E/Z Rescue comes complete with an actuator motor, small key chain remote and new 120 pound hydraulic shock. Installation instructions, door and pan etched rescue bracket placement and free technical support are included.

# EZ AC ADAPTER SYSTEMS FOR FORD AND CHEVROLET TRUCKS

## BECAUSE YOUR K9 DESERVES FIRST-CLASS AC

### Redefining Rear AC

The EZ AC Adapter by American Aluminum is a specialized **climate control enhancement** designed for 2021-current Chevrolet Tahoe and crew cab truck models as well as the Ford F-150 and PIU Explorer models, particularly those outfitted for K9 transport. This system **optimizes the vehicle's rear air conditioning vents**, originally located under the front seats, by **redirecting airflow directly into the K9 compartment**. This targeted airflow **ensures that working dogs receive immediate and efficient cooling**, especially after intense activity.

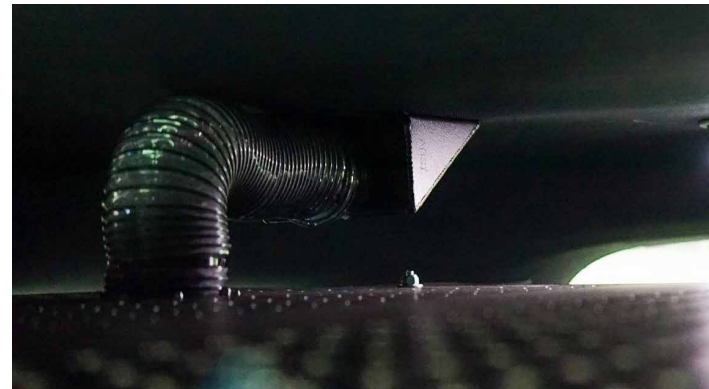

### Small Upgrade. Major Impact.

When a working dog begins to overheat, they often lay on the floor of the unit. While the vehicle is temperature-controlled through the factory HVAC system, the installed K9 insert blocks direct airflow from the factory vents. As a result, the K9 is exposed only to the ambient temperature of the vehicle. **Our system solves this problem by directing airflow from the factory vents to the area where the dog is located, ensuring they receive the necessary ventilation to stay cool.**

### Why Choose the EZ AC Adapter?

- ✔ **Trusted by Professionals** – Designed with direct input from law enforcement and K9 handlers — built to meet real-world demands.
- ✔ **Dedicated to K9 Safety** – Every detail is engineered with your working dog's comfort and well-being as the top priority.
- ✔ **Made in the USA** – Proudly manufactured with precision and care, supporting American craftsmanship and quality standards.



## KEY FEATURES & BENEFITS

- ✔ **Targeted Airflow**  
Strategically redirects rear A/C vents to **deliver cool air** directly into the K9 compartment, **enhancing comfort for the K9** occupant.
- ✔ **Vehicle-Specific Design**  
Engineered for **2021-current Chevrolet Tahoe, Ford F-150, and Ford PIU models**, efficiently redirecting factory rear A/C airflow into the K9 compartment for improved cooling performance.
- ✔ **Enhanced K9 Welfare**  
**Provides rapid cooling to the K9 area**, crucial for the health and performance of working dogs in various conditions.
- ✔ **Durable Construction**  
**Built with high-quality materials** to withstand the demands of law enforcement and working dog environments.
- ✔ **Easy Installation**  
Designed for **quick and hassle-free setup** with minimal modifications required—**get up and running in no time.**
- ✔ **Compatible with K9 Inserts**  
Works seamlessly alongside American Aluminum's K9 transport inserts, making it a **perfect upgrade for your existing setup.**

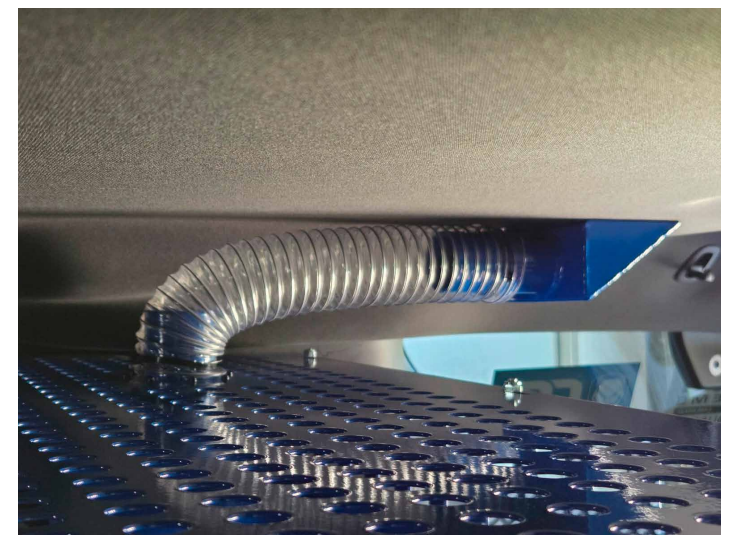



## OPERATION SCREEN

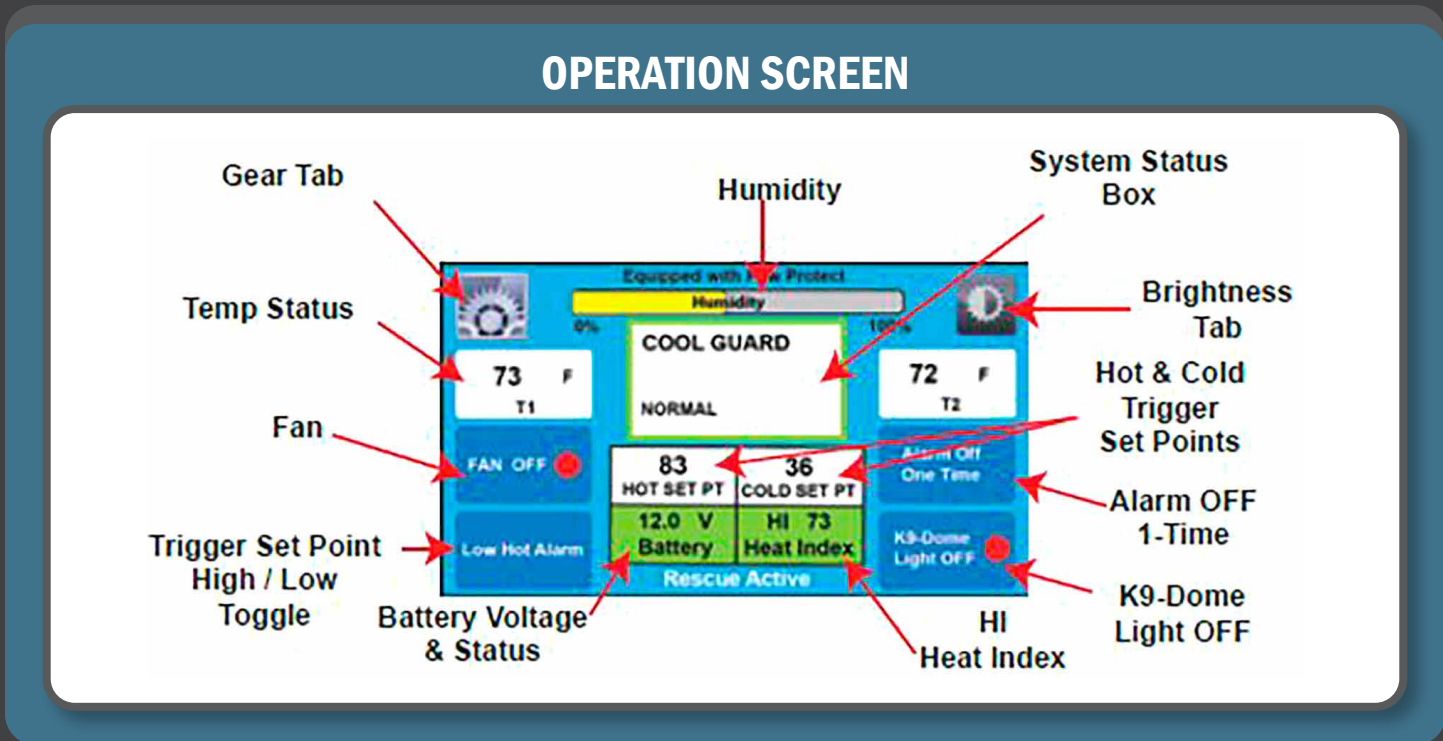

### HOW TO USE:

Once wiring has been completed, turn on the key/ignition. This will power up the unit, it will cycle through our logo and contact info, and then scroll to the cool down screen. This gives the handler 10 minutes to cool down the vehicle before arming the K9 alarm system.

An additional 5 minutes can be added at this screen if needed when starting up the vehicle. Then the unit will automatically scroll to the main operation screen, or be bypassed to go straight to the armed operation screen.

Once the cool down time has been elapsed or bypassed, the home

screen will be displayed. This will show the 2 temps, the humidity %, and display a green normal square for in park and acceptable temperature, a black square for in gear and alarm can not sound, a yellow square for heat warning, and a red square for hot or cold alarm, and a yellow or black square for different system faults.



# COOLGUARD PLUS M910 SERIES

The M910 series keeps the functions of the standard style CoolGuard: Monitors the temperature, has 2 settings, high and low, to toggle from four season changes, rolls windows down, turns fan on, and sends a pulse for the horn and pager, and still universal for all makes and model vehicles.

### NEW FUNCTIONS:

- 2 outputs for emergency lights
- Pager signal alerts for alarm AND low battery
- Heat alarm calculates for heat AND humidity
- 2 temp probes now for best temp accuracy
- Alarm set for hot AND cold temps

- 2 Fan outputs
- Vehicle in drive disable- disarms the alarm while the vehicle is in drive
- 5 minute disable- disarms the alarm after the 10 minute cooldown for 5 minutes, and then rearms by a touch or after the 5 minutes has timed out
- Equipment test- press the equipment test button and then press alarm functions individually or press start test to test all functions
- Alarm history- in settings, the history for both equipment test and alarm history are stored for service and diagnostics
- Paw Protect- Alarm turns on with vehicle, stays monitoring after vehicle turns off, must remove dog and press PawProtect button to turn off.

### ALARM STATUS INDICATORS



## HOW TO TEST YOUR SYSTEM

At any time you can test your system after it is installed, simply press the gear button and then equipment test, or press the equipment test button- depending on which screen you are at.

Then press the items you wish to test or press system test and it will test all that are hooked up. When complete, press the gear and then operation to return to the home screen to resume normal operation.



## TO TURN OFF YOUR UNIT

Turn the key/ ignition off. This will make the display screen go dim and the screen will beep at you to indicate ignition has been lost. After this, the alarm will continue to monitor but is looking for the paw protect button to be pressed. This means to get out, remove the dog, and press the paw protect button located just inside the cage on the clear poly by the grab handle to turn off the alarm and discontinue monitoring. After pressing the paw protect, the alarm will turn off.



## ALARM AND EVENT HISTORY

Both Histories are used for documentation. This is to show how many times the alarm was tested, what failed during the test if it failed, and when the alarm went off from hot or cold temperatures. This is used for troubleshooting, as well as if the agency needs to know when something failed. All this documentation is saved to the unit permanently. We still recommend that the unit be tested at least once a week, and/or no less than once a month.

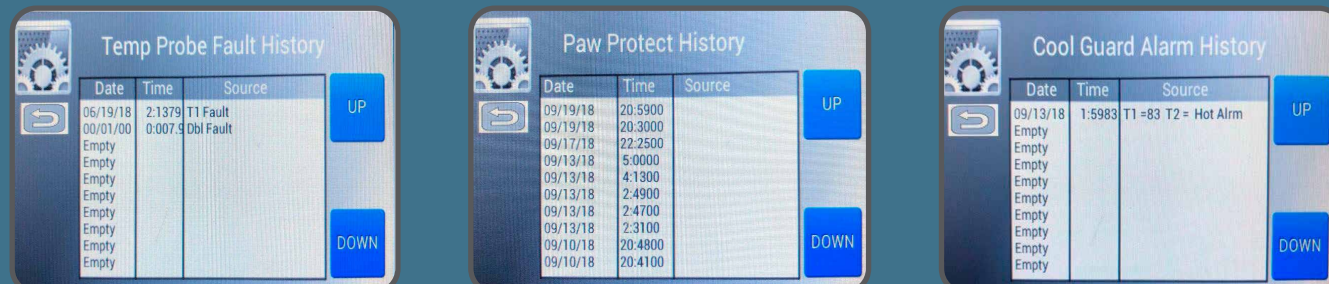

# COOLGUARD 360 MOBILE APP

PRODUCT NUMBER: SA-10521

SECURE. DURABLE. MISSION-READY

CoolGuard 360 is a smartphone-based app that works with the CoolGuard K9 temperature safety system installed in police K9 vehicles. It allows handlers to monitor and control the vehicle environment remotely from their phone, helping keep their K9 safe inside the patrol vehicle. In a temperature emergency, the CoolGuard system automatically cracks the windows and activates alarms to protect the K9, no action required from the app.

## Built for Performance

The Cool Guard 360 is installed in the vehicle and monitors temperature (via two probes), humidity, K9 cage door status, ignition status, and battery voltage. This data is transmitted in real time via cellular connectivity to the cloud, making it instantly accessible through the website and mobile apps.

## Ready to set up your app?

Contact us today to learn more about our CoolGuard 360 app.

(800) 277-0869

8:00am to 4:30pm EST

EzRiderOnline.com



## COOLGUARD 360

When conditions reach critical thresholds, high temperature, low temperature, low battery, or probe faults, the system sends alerts via email, text, and/or push notifications to the handler, their designated contacts, and all department dispatchers.

Instead of relying only on the in-vehicle display or pager, the handler can monitor the K9 unit from anywhere using their phone.

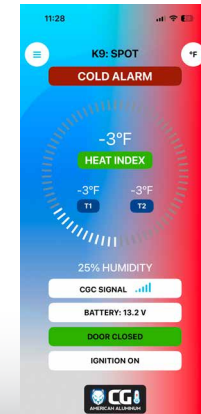

### COLD ALARM

The cold alarm triggers when the temperature inside the K9 compartment drops below the preset cold limit, alerting the handler that the dog maybe getting too cold.

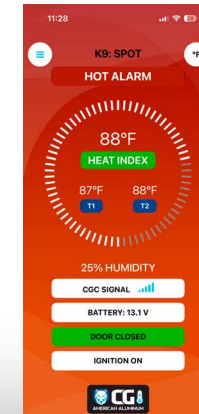

### HEAT ALARM

The heat alarm activates when the temperature inside the K9 compartment rises above the preset limit, alerting the handler that the dog may be getting too hot.

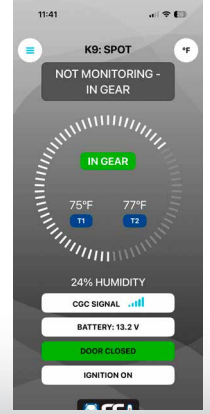

### IN GEAR NOT MONITORING

The system does not monitor temperature or trigger alarms while the vehicle is in gear, since the vehicle is assumed to be actively driven by the handler.

## KEY FEATURES & BENEFITS

- Three Primary Users**  
 Department admins, Handles, Dispatchers. Each manage department accounts, handlers, alerts, and monitoring data while allowing individual K9 officers to track their K9's environment and notification settings.
- Real Time Monitoring**  
 The Monitoring page displays real-time data for all handlers, sourced from the Cool Guard 360 devices in each vehicle.
- Reports: Alarm Events**  
 View alarm history across all handlers with date range filtering and export capabilities.
- Reports: Device Tracking & QC**  
 Tracks all Cool Guard 360 devices in the field. Quality Control test result confirming hardware is operating properly.
- Data Flow**  
 Device in vehicle > Cellular > Cloud > Website & Mobile Apps
- Mobile App Additional Features**  
 Contacts, K9 Photo, Account Settings, Tech Support.

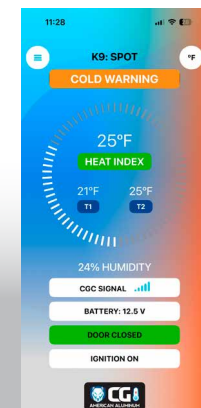
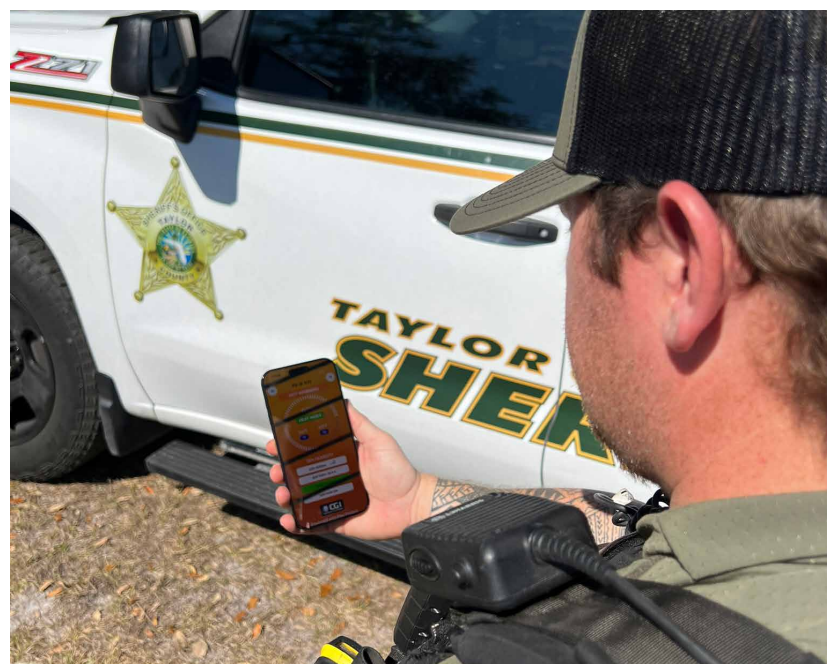

### COLD WARNING

Detects when the temperature begins to drop below the safe limit, giving the handler time to make adjustments before the cold alarm is triggered.

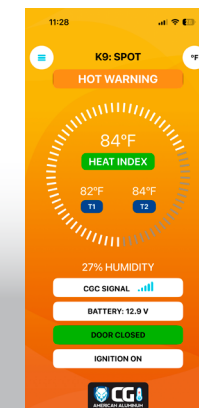

### HOT WARNING

Detects when the temperature begins to rise toward the unsafe limit, giving the handler time to make adjustments before the heat alarm is triggered.

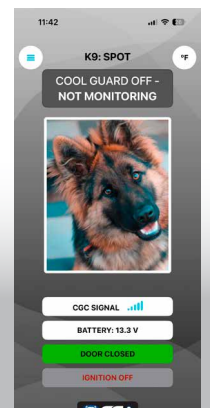

### COOL DOWN

Gives the officer time to adjust the vehicle's AC system and stabilize the internal temperature of the K9 compartment before conditions reach an unsafe level.



# K9 WEAPON STORAGE SOLUTION

## BLAC-RAC + AMERICAN ALUMINUM ACCESSORIES

Access to your four-legged partner shouldn't come at the expense of secure weapon storage. In many vehicle setups, installing a K9 cage has traditionally eliminated convenient mounting locations for a firearm retention system — until now.

Through the integration of American Aluminum Accessories K9 transport solutions and Blac-Rac weapon retention systems, Team GJ has engineered a purpose-built mounting solution that eliminates this gap. Dedicated brackets allow mounting either on the K9 access door or above the cage, maintaining full usability of the enclosure while providing immediate access to your firearm.

Officers gain fast, ergonomic reach when it matters most, paired with the proven security and retention performance Blac-Rac is trusted for in the field.

### KEY BENEFITS

- Maintains Full K9 Cage Functionality and Access
- Multiple Mounting Locations: Door-Mounted or Overhead
- Fast, Intuitive Firearm Access
- Secure Retention Trusted by Law Enforcement
- Purpose-Built Integration Between AAA and Blac-Rac products

Blac-Rac's **Single Point Mounting** offers versatile placement options, accommodating a vertical or horizontal installation to your K9 Unit.



LEARN MORE ABOUT  
**BLAC-RAC**  
WEAPON RETENTION SYSTEMS



## AMERICAN ALUMINUM ACCESSORIES E/Z RIDER K9 UNIT

- **PURPOSE-BUILT FOR K9 LAW ENFORCEMENT:** Designed for police K9 units, this unit provides a secure, comfortable space for your canine partner while minimizing distractions for the officer.
- **ENHANCES OPERATIONAL EFFICIENCY:** A dedicated, secure compartment keeps your K9 mission-ready, allowing officers to focus on critical tasks with confidence.
- **INTEGRATED FAN SHELF:** A dedicated, secure compartment keeps your K9 mission-ready, allowing officers to focus on critical tasks with confidence.



## BLAC-RAC WEAPON RETENTION SYSTEMS

- **DURABLE MATERIALS:** Cast stainless-steel and Aluminum Billet construction provides exceptional durability, effectively resisting corrosion while ensuring unmatched strength and security.
- **COLD-WIRE TECHNOLOGY:** Cold-Wire Technology system employs a signal code generator, rendering the lock impervious to tampering via cut power wires and external power sources. Each transmitter supports up to two racks.
- **ENHANCED SECURITY:** Many of our mounts are adjustable which ensures a secure weapon mount, minimizing vibrations and preventing annoying rattling.



### CUSTOM BRACKET FROM AMERICAN ALUMINUM ACCESSORIES

Securely mount your Blac-Rac to the top of your K9 Kennel with this custom solution.



PRODUCT NUMBER	DESCRIPTION
SA-11215	BLACK RAC K9-11-19 INTERCEPTOR BLACK RAC MOUNT SUBASSEMBLY
SA-11216	BLACK RAC K9-2021-CURRENT INTERCEPTOR BLACK RAC MOUNT SUBASSEMBLY
SA-11217	BLACK RAC K9-2015-CURRENT F150 IK BLACK RAC MOUNT SUBASSEMBLY
SA-11218	BLACK RAC K9-2021-CURRENT CHEVY TAHOE AND SUBURBAN BLACK RAC MOUNT SUBASSEMBLY
SA-11219	BLACK RAC K9-2019-CURRENT CHEVY CREW CAB BLACK RAC MOUNT SUBASSEMBLY
SA-11220	BLACK RAC K9-OFFSET BRACKET BLACK RAC SUBASSEMBLY

**WANT TO LEARN MORE ABOUT BLAC-RAC?**

Call: 800.528.8040  
Email: [info@blac-rac.com](mailto:info@blac-rac.com)  
Website: [BlacRac.com](http://BlacRac.com)

## E/Z RIDER UNIVERSAL UTILITY COMBO

### THE CONVENIENCE OF K9 TRANSPORT AND STORAGE SOLUTIONS IN ONE

Our E/Z Rider Universal Utility Combo offers the convenience of K9 transport and storage solutions in one! The Combo Unit comes with attached 2 drawer storage unit and top storage shelf area. The storage drawers are 8" deep and also come with the Camlocker locking t-handle for additional security. A solid unit, but storage area can be detached easily if need be by removing 6 bolts. K-9 Portion features removable base pan for easy cleaning, and includes our heavy-duty fitted K9 rubber mat. Available in Full Size (for larger SUV's) and Down Size models (for smaller SUV's).

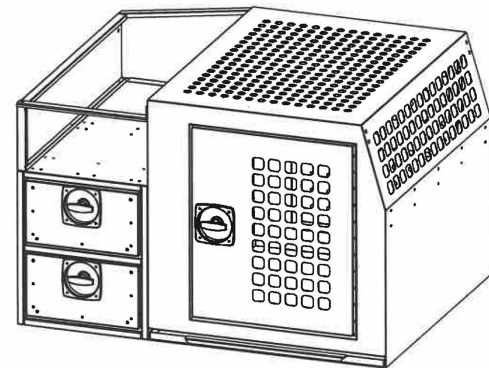

## E/Z RIDER UNIVERSAL UTILITY VEHICLE SLIDE IN

The E/Z Rider Universal Utility Slide-In aka "UUV" is a universal canine transport solution for those wishing to utilize the cargo area of their SUV, while allowing for the middle seat area to remain free and in an upright position. Hinged front door with folding T-handle lock and emergency escape rear drop down window. Comes fully assembled and can also be used for off-duty, in-house containment. Features includes a removable base and rubber mat for easy cleaning. Available in Full Size (for larger SUV's) and Down Size models (for smaller SUV's and 2-compartment units).

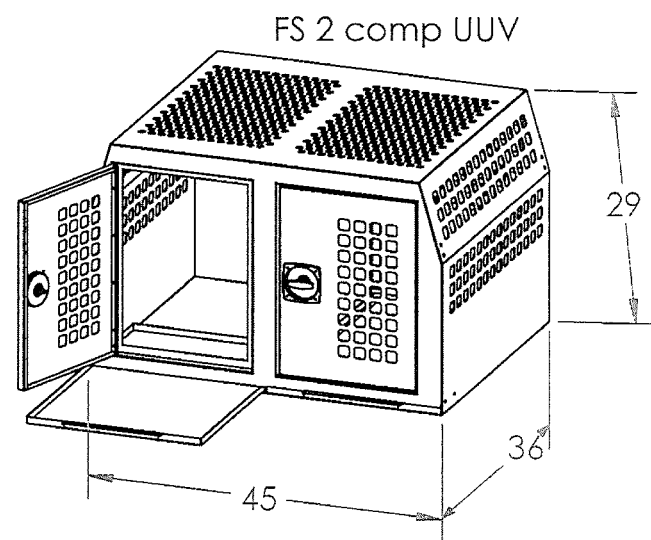

### UNIVERSAL K9 PRODUCTS

PRODUCT NUMBER	DESCRIPTION
AA-K9-01-100-1	K9-UUV 28X29X40 (L, H, W) DOWNSIZE INTERCEPTER SUV (DOES NOT FIT CIVILIAN EXPLORERS)
AA-K9-01-101-1	K9-UUV SLIDE-IN-COMBO-DOWN SIZE-30X28X29-MATTE BLAck
AA-K9-01-200-1	K9-UUV SLIDE-IN-COMBO-2025 COMMERCIAL ISUV EXPLORER-41x37X26-MATTE BLACK
AA-K9-01-201-1	K9-UUV SLIDE-IN-33X33X29-COMMERCIAL EXPLORER-MATTE BLACK
AA-K9-01-300-1	K9-UUV SLIDE-IN-COMBO-2021-CURRENT-CHEVY TAHOE-45X34X29-MATTE BLACK
AA-K9-01-301-1	K9-UUV SLIDE-IN-COMBO-45X34X29-FULL SIZE-MATTE BLACK
AA-K9-01-302-1	CUSTOM BROWARD COUNTY 2 COMP UUV 22.5X36X29
AA-K9-00-100-1	K9-UUV SLIDE-IN-45X36X29-FULL SIZE
AA-K9-00-200-1	K9-UUV SLIDE-IN-45X34X31-TWO COMPARTMENT
AA-K9-00-201-1	K9-UUV SLIDE-IN-38X33X29-TWO COMPARTMENT
AA-K9-00-202-1	K9-UUV SLIDE-IN-45X36X29-TWO COMPARTMENT
AA-K9-00-203-1	K9-UUV SLIDE-IN-CUSTOM TWO COMPARTMENT-ONE DRAWER 7INCH HIGH ON BOTTOM WITH SOLID DIVIDER
AA-K9-00-300-1	K9-UUV SLIDE-IN-38X33X29-DOWN SIZE-MATTE BLACK
AA-K9-01-200-1	K9-UUV SLIDE-IN-COMBO-2025 COMMERCIAL ISUV EXPLORER-41x37X26-MATTE BLACK
AA-K9-01-201-1	K9-UUV SLIDE-IN-33X33X29-COMMERCIAL EXPLORER-MATTE BLACK
AA-K9-01-300-1	K9-UUV SLIDE-IN-COMBO-2021-CURRENT-CHEVY TAHOE-45X34X29-MATTE BLACK
AA-K9-01-301-1	K9-UUV SLIDE-IN-COMBO-45X34X29-FULL SIZE-MATTE BLACK
AA-K9-01-302-1	CUSTOM BROWARD COUNTY 2 COMP UUV 22.5X36X29
AA-K9-00-100-1	K9-UUV SLIDE-IN-45X36X29-FULL SIZE
AA-K9-00-200-1	K9-UUV SLIDE-IN-45X34X31-TWO COMPARTMENT
AA-K9-00-201-1	K9-UUV SLIDE-IN-38X33X29-TWO COMPARTMENT
AA-K9-00-202-1	K9-UUV SLIDE-IN-45X36X29-TWO COMPARTMENT
AA-K9-00-203-1	K9-UUV SLIDE-IN-CUSTOM TWO COMPARTMENT-ONE DRAWER 7INCH HIGH ON BOTTOM WITH SOLID DIVIDER
AA-K9-00-300-1	K9-UUV SLIDE-IN-38X33X29-DOWN SIZE-MATTE BLACK

# COLLAPSIBLE & STANDARD CRATES

COLLAPSIBLE CRATE & STANDARD CRATE SIZE MEASUREMENTS					
PRODUCT NUMBER	DESCRIPTION	SIZE	WIDTH	LENGTH	HEIGHT
AA-K9-02-105-1	K9-COLLAPSIBLE CRATE 25X36X27	LARGE	25"	36"	27"
AA-K9-02-106-1	K9-COLLAPSIBLE-XLCRATE-27X42X30	XL	27"	42"	30"
AA-K9-02-107-1	K9-COLLAPSIBLE-XXL CRATE-32X48X32	XXL	32"	48"	32"
AA-K9-02-101-1	K9-NON-COLLAPSIBLE CRATE 25X36X27	E/Z-Crate *Non collapsible	25"	36"	27"





## HOME KENNEL

### FEATURES

- Adjustable vents on each side, removable top with easy access latch and is insulated
- Sides are .100 aluminum with aluminum finish
- Floor frame, door 12" tall legs are .125 aluminum with aluminum finish
- Powder coat
- Secure lock and latch covers
- Locking folding t-handle
- Pvc covered floors are sloped toward the drain for easy cleaning and draining
- Anti-rust hardware

PRODUCT NUMBER	DESCRIPTION
AA-K9-02-108-5	K9-PORTABLE KENNEL-II-KENNEL RUN-ADJUSTABLE VENTS-96X41.5X48 SKY WHITE
SA-11236	ANIMAL CONTROL-K9-PORTABLE KENNEL-I-KENNEL RUN-96X41.5X48 SUB-ASSEMBLY
SA-11237	ANIMAL CONTROL-K9-KENNEL LEGS FOR PORTABLE KENNEL II SUB-ASSEMBLY
SA-10762	K9 DOG KENNEL-DOG HOUSE SUB ASSEMBLY

## TESTIMONIALS

### TESTIMONY 1

K9 Officer Pratte with the Bow, NH Police Department was involved in a serious accident. He was rear ended on the highway resulting in substantial damage and totaling his cruiser.

Officer Pratte "Just wanted to say thanks because the AA insert kept K9 Roxy safe and she made it out uninjured."

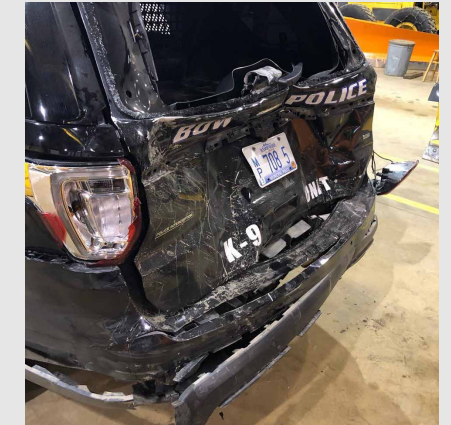
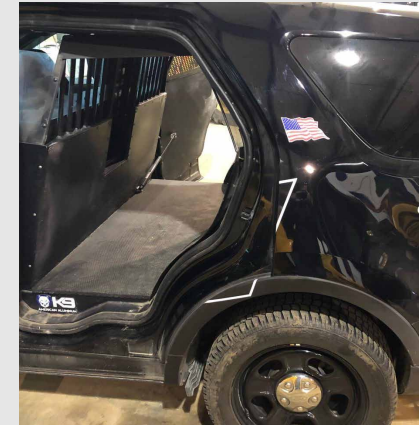

### TESTIMONY 2

"Just wanted to say thanks for building a good product IT SAVED MY K9 PARTNER FOR SURE. We will be putting another one in my new car." Officer Wingfield

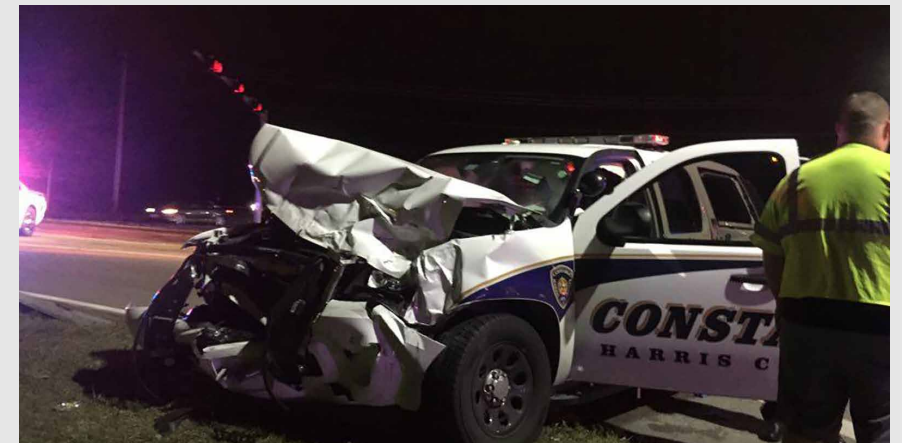

### TESTIMONY 3

While on the interstate this officer and his canine partner was rear ended on the interstate at 70 mph... We are proud to say that his canine partner was not harmed during this crash, the K-9 platform did get slightly bent but did not collapse and done exactly what it was built to do.

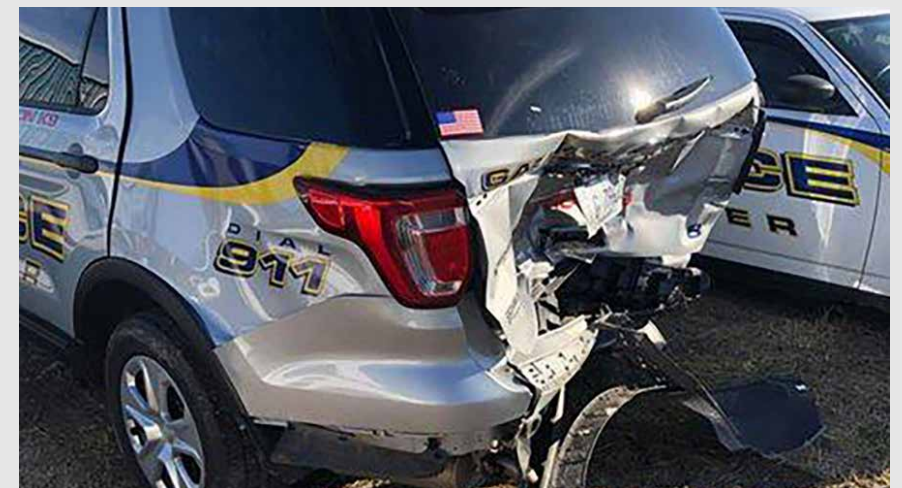



## DESIGNED FOR LAW ENFORCEMENT

Vault Systems are designed for Law Enforcement use to keep equipment and ordinance secure in Sedan or SUV vehicles. The Vault systems are lightweight, yet rugged, built of mill finish. Standard features include: slide out drawer(s), CamLocker locking mechanism, interior carpet, exterior top carpet. A top basket, black matte powder coat, and optional

interior weapon foam. Load it and lock it knowing your equipment is safe and secure.

Our relationships with Law Enforcement agencies around the world, has given American Aluminum the opportunity to design and manufacture many variations of our Vault Systems. Agencies have specified number of drawers,

size of drawers, and location. We have even designed command centers with pull out marker boards to communicate with the team on-site. Pricing and availability will vary with the requested design. A sales professional stands ready to talk with you about the available configurations shown here.



## DESIGNED TO STORE WEAPONS AND EQUIPMENT SECURELY IN YOUR VEHICLE

### STANDARD FEATURES

- Mill finish and powder coated aluminum.
- Slide out drawer(s) come with our Cam-Lock and Simplex Combination locking mechanisms.
- Interior carpet, exterior top carpet. Interior weapon foam (optional).
- 4" basket on top.
- Optional map drawers
- Can be custom designed to the specifications required by your agency or personal preference. This includes the number, sizes, and location of drawers.

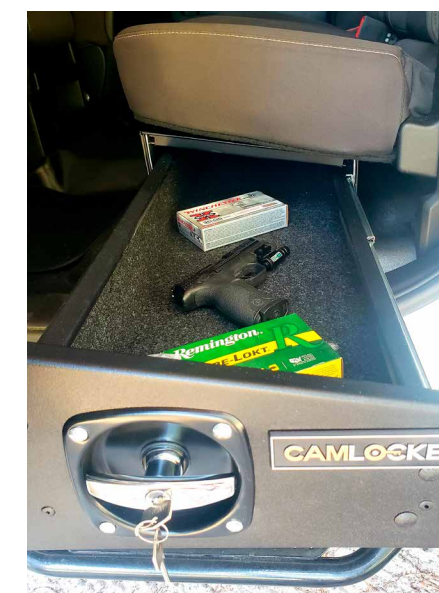
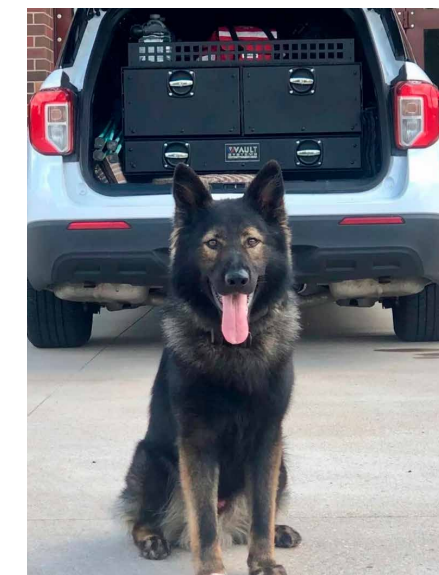

## AAA UP VAULT

Comes with 11-gauge steel brackets that attach to the OEM bolts of the vehicle for an easy and secure install.

These brackets raise the vault from the floor of the vehicle to allow access to the spare tire from the factory placement and store any additional equipment.



Featured above is the new and improved "UP" vault for the new Ford Interceptor 2020! The new UP vault features 11 ga steel brackets... 5 easy parts that attach to the OEM bolts of the vehicle for an easy and secured install. The vault outer measurements are 44"Wx24"Dx8"H. It is designed to allow the vault to be positioned in a way that allows most rear partitions. The vault also allows for the spare tire to stay in place but it leaves enough clearance for it to be taken out. Brackets are 11" from the floor.

## TWO DRAWER VAULTS WITH ELECTRONIC BASKET



## SINGLE DRAWER VAULT WITH ELECTRONIC BASKET



## COMMAND VAULT

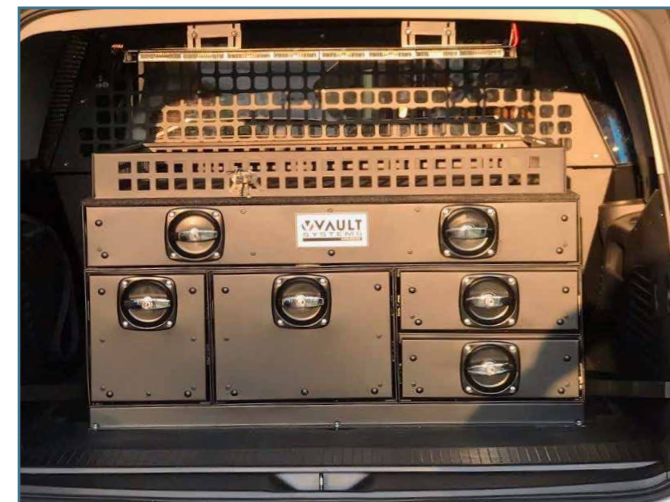

## UNDER THE SEAT TRUCK VAULT



The Dodge Durango Up Vault fits years 2011-2020. 41"Wx24"Dx8"H. Bracket is 11" from the floor.

Comes powder coated matte black and the basket is included.



Another top seller is the new Up Vault for the Chevy Tahoe. The new raised Tahoe Vault has a "U" shaped bracket 10"H.

VT above is 48"x28.5"x12". It comes standard matte black with basket and carpet on top.

## THE ULTIMATE IN QUALITY: AMERICAN MADE CRAFTSMANSHIP

Hand crafted and assembled by expert craftsmen means the vault will operate as designed for years and years to come. Your high value equipment will be secure for transport locked tight with the CamLocker system with proprietary keying mechanism available only through American Aluminum. Lightweight and built to last. American Aluminum Vault systems come in many configurations to fit your vehicle and secure the equipment you use to do your job. Built for Sedans and SUVs, we have a Vault that will exceed your transport needs.

# SUV UNIVERSAL VAULT SETUPS

This vault is a 41" x 24" x 8" vault that was originally built for the Dodge Durango. We have added more holes to the bottom of the vault to be able to mount it to the ISUV bracket and the 21 Tahoe bracket. The Durango bracket is made from .125 mil finish aluminum. The other two are made from 11GA CRS.

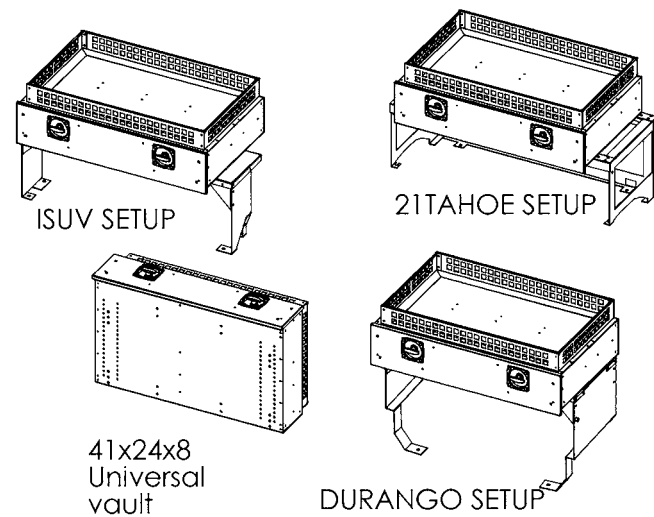

## VAULT PRODUCT SELECTION

UNIVERSAL	
PRODUCT NUMBER	DESCRIPTION
AA-VT-70-002-1	UP VAULT-UNIVERSAL-41X24X8

NISSAN	
PRODUCT NUMBER	DESCRIPTION
AA-VT-10-009-1	1DRAWER-40X16X8-NISSAN ALTIMA
AA-VT-10-016-1	1DRAWER-40X20X8-NISSAN PATHFINDER-2022

JEEP	
PRODUCT NUMBER	DESCRIPTION
AA-VT-10-010-1	1DRAWER-43X12X8-JEEP GRAND CHEROKEE

TOYOTA	
PRODUCT NUMBER	DESCRIPTION
AA-VT-10-017-1	1DRAWER-38X28.5X16-TOYOTA RAV4

DODGE	
PRODUCT NUMBER	DESCRIPTION
AA-VT-10-002-1	1DRAWER-36X15X8-DODGE CHARGER
AA-VT-10-003-1	1DRAWER-GUN VAULT-43X8X8-DODGE CHARGER
AA-VT-10-004-1	1DRAWER-40X23X12-DODGE DURANGO
AA-VT-20-008-1	2DRAWER-40X28X6BOTTOM-40X28X12TOP-DODGE DURANGO-2021-2022
AA-VT-30-008-1	3DRAWER-40X28.5X18-DODGE DURANGO
AA-VT-50-001-0	5DRAWER-40X28.5X18-DODGE-DURANGO- 2011-2022 COMMAND VAULT W/BASKET
AA-VT-70-001-1	UP VAULT-DURANGO-2019-CURRENT
AA-VT-80-004-0	40X28.5X12 CUSTOM DURANGO VAULT WITH CUSTOM LEGS

UNDERSEAT VAULTS	
PRODUCT NUMBER	DESCRIPTION
AA-VT-80-001-1	13X43X7-CHEVY CREW CAB-2019-2022
AA-VT-80-002-1	13.8X42X8.25-FORD F150-2015-2021
AA-VT-80-003-1	43X12X8-CHEVY CREW CAB-2018
AA-VT-99-015-1	12X12X7-GUN BOX

FORD	
PRODUCT NUMBER	DESCRIPTION
AA-VT-10-006-1	1DRAWER-40X23X12-FORD ESCAPE
AA-VT-10-007-1	1DRAWER-45X28.5X12-FORD EXPEDITION
AA-VT-10-008-1	1DRAWER-FORD CROWN VIC
AA-VT-10-012-1	1DRAWER-38X32X12-FORD EXPLORER
AA-VT-10-014-1	1DRAWER-3COMP COMBO-44X24X18-ISUV
AA-VT-20-001-1	2DRAWER-40X28.5X18BOTTOM-24X28.5X12TOP
AA-VT-20-002-1	2DRAWER-40X23X12BOTTOM-40X23X6TOP-FORD ISUV-2020-CURRENT
AA-VT-20-021-1	40X23X18 2 DRAWER ISUV VAULT
AA-VT-30-001-1	3DRAWER-20X24X12-FORD ISUV-2020-2022
AA-VT-30-002-1	3DRAWER-INTOXILIZER COMBO-40X28.5X24-FORD ISUV-2011-2019
AA-VT-30-006-1	3DRAWER-40X28.5X12-FORD ISUV
AA-VT-30-009-1	3DRAWER-20X28.5X12BOTTOM2-43X28.5X6TOP-FORD EXPEDITION
AA-VT-30-010-1	3DRAWER-40X28.5X18-FORD ISUV
AA-VT-30-011-1	3DRAWER-40X24X18-FORD ISUV
AA-VT-40-001-1	4DRAWER-FORD ISUV-2020-2022
AA-VT-40-003-1	2025-CURRENT EXPEDITION UP VAULT
AA-VT-40-006-0	2020-2022 FORD ISUV UP VAULT W/ ELECTRONICS DRAWER
AA-VT-50-002-0	2025-CURRENT EXPEDITION COMMAND VAULT 45x32x18
AA-VT-50-004-0	40X28.5X18 ISUV COMMAND VAULT
AA-VT-70-003-1	UP-VAULT-44X24X8-FORD ISUV-2011-2019
AA-VT-70-004-1	UP-VAULT-44X24X8-FORD ISUV-2020-CURRENT
AA-VT-70-005-1	UP-VAULT-45X24X6-DOUBLE STACKED-FORD ISUV-2011-2019
AA-VT-70-006-1	UP-VAULT-44X24X8-15INCH BRACKET-FORD ISUV-2011-2019
AA-VT-70-012-1	UP-VAULT-ELECTRONICS TRAY COMBO-44X24X8-FORD ISUV-2020-CURRENT
AA-VT-80-005-1	40X28.5X12 CUSTOM FORD ESCAPE VAULT
AA-VT-90-002-1	COMMAND-40X28.5X18-FORD ISUV
AA-VT-90-003-1	COMMAND-45X23X18-FORD EXPEDITION-2018-2023

CHEVY	
PRODUCT NUMBER	DESCRIPTION
AA-VT-10-005-1	1DRAWER-36X23X12-CHEVY EQUINOX
AA-VT-10-015-1	1DRAWER-36X23X12-JEEP LIBERTY-CHEVY EQUINOX
AA-VT-10-019-1	1DRAWER-48X23X12-CHEVY TAHOE-2000-2014
AA-VT-10-020-1	1DRAWER-48X28.5X12-CHEVY TAHOE-2000-2014
AA-VT-10-021-1	1DRAWER-48X28.5X12-CHEVY TAHOE-2015-2020
AA-VT-10-022-1	1DRAWER-LOW BRACKET-48X28.5X12-CHEVY TAHOE-2021-CURRENT
AA-VT-10-023-1	1DRAWER-48X36X12-CHEVY TAHOE-2000-2014
AA-VT-10-024-1	1DRAWER-45X23X12-FLOOR MOUNT-CHEVY TAHOE-2015
AA-VT-10-026-1	JSP Scale Vault 23
AA-VT-10-027-1	2015 AND PRIOR CHEVY TAHOE FLOOR MOUNT 1 DRAWER 45X28.5X12 VAULT
AA-VT-20-003-1	2DRAWER-45X28.5X10-CHEVY TAHOE-2021-CURRENT
AA-VT-20-004-1	2DRAWER-45X28.5X12-CHEVY TAHOE-2021-CURRENT
AA-VT-20-005-1	2DRAWER-COMBO-4COMP NARCSAFE-CHEVY TAHOE-2021-CURRENT
AA-VT-20-006-1	2DRAWER-45X23X12-CHEVY TAHOE-2015-2020
AA-VT-20-007-1	2DRAWER-45X28.5X12-CHEVY TAHOE-FORD EXPEDITION-2015-2020
AA-VT-20-012-1	2DRAWER-48X23X12-CHEVY TAHOE-2000-2014
AA-VT-20-013-1	2DRAWER-45X23X12-CHEVY TAHOE-2015-2020
AA-VT-20-014-1	2DRAWER-45X28.5X12-CHEVY TAHOE-FORD EXPEDITION-2000-2014
AA-VT-20-015-1	2DRAWER-45X28.5X12-CHEVY TAHOE-FORD EXPEDITION-2015-2020
AA-VT-20-016-1	2DRAWER-45X28.5X12-45X28.5X6-CHEVY TAHOE-FORD EXPEDITION-2015-2020
AA-VT-20-017-1	2DRAWER-NASSAU STYLE-30X23X12- 18X34X12-CHEVY TAHOE-FORD EXPEDITION-2000-2014
AA-VT-20-020-1	2DRAWER-CHEVY TAHOE-2021-CURRENT 6' TOP DRAWER WITH 12" BOTTOM DRAWER
AA-VT-30-003-1	3DRAWER-INTOXILIZER COMBO-45X28.5X24-CHEVY TAHOE-2021-CURRENT
AA-VT-30-004-1	3DRAWER-45X24X18-CHEVY TAHOE-2021-CURRENT
AA-VT-30-005-1	3DRAWER-COMBO-45X28.5X24-CHEVY TAHOE-2021-CURRENT
AA-VT-30-007-1	3DRAWER-30-28.5X12-CHEVY TAHOE-2000
AA-VT-40-002-1	4DRAWER-CHEVY TAHOE
AA-VT-40-005-0	2021 CHEVY TAHOE UP VAULT WITH ELECTRONICS COMBO DRAWER AND BASKET
AA-VT-40-007-1	2025-CURRENT 42X18X8 EV BLAZER UP VAULT
AA-VT-50-003-0	2021 TAHOE COMMAND VAULT WITH SIMPLEX LOCK 45X28.5X18
AA-VT-50-005-0	2021 TAHOE COMMAND VAULT 45X28.5X18
AA-VT-70-007-1	UP-VAULT-45X28.5X10-CHEVY TAHOE-2021-CURRENT
AA-VT-70-010-1	UP-VAULT-43X12X8-CHEVY TRAVERSE
AA-VT-70-011-1	UP-VAULT-ELECTRONICS BASKET COMBO-45X28.5X10-CHEVY TAHOE-2021
AA-VT-70-013-1	UP-VAULT-45X28.5X10-9INCH BRACKET-CHEVY TAHOE-2021-CURRENT ESCAMBIA
AA-VT-90-001-1	COMMAND-45X28.5X18-CHEVY TAHOE



## STANDARD & EXTENDED VAN



## SAFE AND SECURE TRANSPORT SYSTEMS FOR INMATES

American Aluminum manufactures safe and secure transport systems for inmates, originally designed to slide in the Ford Econoline vans. A lot has changed since the first units were designed, manufactured and installed 25 years ago. Multi-compartment designs, polycarbonate covers on openings, and emergency front exit windows are an example of new features that have been added over the years.

Standard features now include seat belts for every passenger, 6000 pound “bursting strength”

slam latches with lockable T-handles, LED security recessed lighting, non-skid seat covering and a smooth interior, sealed to prohibit the hiding of contraband.

We offer Inmate units for the Ford Transit and GM/ GMC vans.

Screen systems are available for Ford E-Series, Ford Transits and all GM/GMC Passenger vans.

### ✓ KEY FEATURES & BENEFITS

- Designed to Accommodate Factory Installed Rear Air or Auxiliary HVAC System
- **Modular Design:** for easy transferring to another van (of same make and length)
- **Built-in Seating:** with skid-resistant covering all seating area
- **High-Strength Seat Belts:** 48” & 60” long, accommodating to a wide range of prisoner sizes
- **Emergency Front Exit Window:** provided with every unit, access from either side
- Poly Carbonate Covered Security Window/Viewpoint on doors
- **6,000 lb “Bursting Strength” Slam Latch:** with key lockable Cam-Handle locks
- **NO ACCESS** to any lock, handle, or opening/closing device from the inside the unit
- **L.E.D. security recessed interior lighting** is included (1 Year Warranty)
- All controls accessed from control switch in the driver area on lockable console
- Overhead ductwork for rear factory A/C & Heat or for Auxiliary A/C and heat included
- **Front Bulkhead:** allows for First Aid and Fire Extinguisher Installation
- **Smooth and Sealed Interior:** for safety and to prevent contraband hiding
- **Non-rusting Aluminum Containers:** allow less down-time for washing and disinfecting
- **Lightweight Build:** for fuel efficiency and vehicle longevity
- **3-Year Warranty on the basic Modular Unit**

## IT UNIT: MAKE & MODEL FIT GUIDE

VEHICLE	COMPARTMENTS	LENGTH	WIDTH	HEIGHT	SEATS
Transit LOWLWB (148"WB)	1Comp	120.00"	60"	49.5"	12
Transit LOWLWB (148"WB)	2-F to B	120.00"	60"	49.5"	12
Transit LOWLWB (148"WB)	2- L to R	120.00"	60"	49.5"	11
Transit LOWLWB (148"WB)	3Comp	120.00"	60"	49.5"	11
<hr/>					
Transit LOWRWB (130"WB)	1 Comp	96"	60"	49.5"	8
Transit LOWRWB (130"WB)	2-F to B	96"	60"	49.5"	8
Transit LOWRWB (130"WB)	2- L to R	96"	60"	49.5"	7
Transit LOWRWB (130"WB)	3Comp	96"	60"	49.5"	7
<hr/>					
Transit MIDLWB (148"WB)	1	120.5"	58"	59.5"	12
Transit MIDLWB (148"WB)	2-F to B	120.5"	58"	59.5"	12
Transit MIDLWB (148"WB)	2- L to R	120.5"	58"	59.5"	11
Transit MIDLWB (148"WB)	3Comp	120.5"	58"	59.5"	11
<hr/>					
Transit MIDRWB (130WB)	1 Comp	104	58"	59.5"	10
Transit MIDRWB (130WB)	2-F to B	104	58"	59.5"	10
Transit MIDRWB (130WB)	2- L to R	104	58"	59.5"	9
Transit MIDRWB (130WB)	3Comp	104	58"	59.5"	9
<hr/>					
Transit HighLWBEL(148"WB)	2- L to R	150"	58"	70"	13
Transit HighLWBEL(148"WB)	3Comp	150"	58"	70"	13
<hr/>					
Transit HighLWB(148"WB)	2- L to R	125.5"	58"	70"	11
Transit HighLWB(148"WB)	3Comp	125.5"	58"	70"	11
<hr/>					
Chevy Std. (135"WB)	2- L to R	96"	60"	49.5"	9
Chevy Std. (135"WB)	3Comp	96"	60"	49.5"	9
<hr/>					
Chevy Extended (155"WB)	1Comp	115"	60"	49.5"	12
Chevy Extended (155"WB)	2-F to B	115"	60"	49.5"	12
Chevy Extended (155"WB)	2- L to R	115"	60"	49.5"	11
Chevy Extended (155"WB)	3Comp	115"	60"	49.5"	11

ONE (1) COMPARTMENT UNIT:

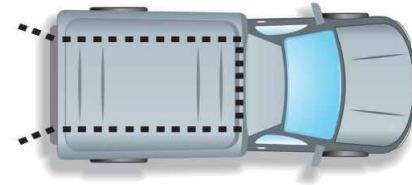

TWO (2) COMPARTMENT UNIT:

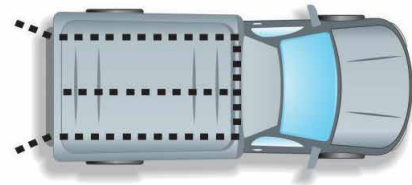

TWO (2) COMPARTMENT UNIT:

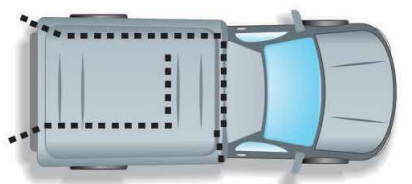

THREE (3) COMPARTMENT UNIT:

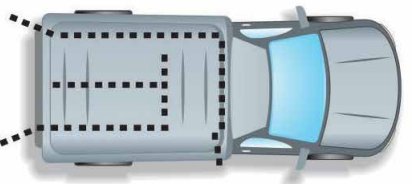

## SWAT VAN

PRODUCT NUMBER	DESCRIPTION
AA-IT-70-001-1	INMATE TRANSPORT 2026 FORD TRANSIT HIGH ROOF STANDARD SWAT
AA-IT-70-003-0	INMATE TRANSPORT-CUSTOM SWAT VAN WITH FOLD DOWN SEATS



### INMATE TRANSPORT: ADA ACCESSIBLE

With our wheelchair accessible transport system, a restraint chair lift is included in your choice of a two or three compartment with the ADA section being one of those compartments. The new design allows different custody levels and genders to be transported at the same time along with a restraint chair.



## OTHER FEATURES

- NEW Hitch Step
- Camera System
- Intercom Systems
- Under-Bench Drawer
- Food Door
- Cushion
- Solid Drop Doors
- Outside Exhaust Vents
- Squish Door
- Side-Step
- Slide-Out Drawer

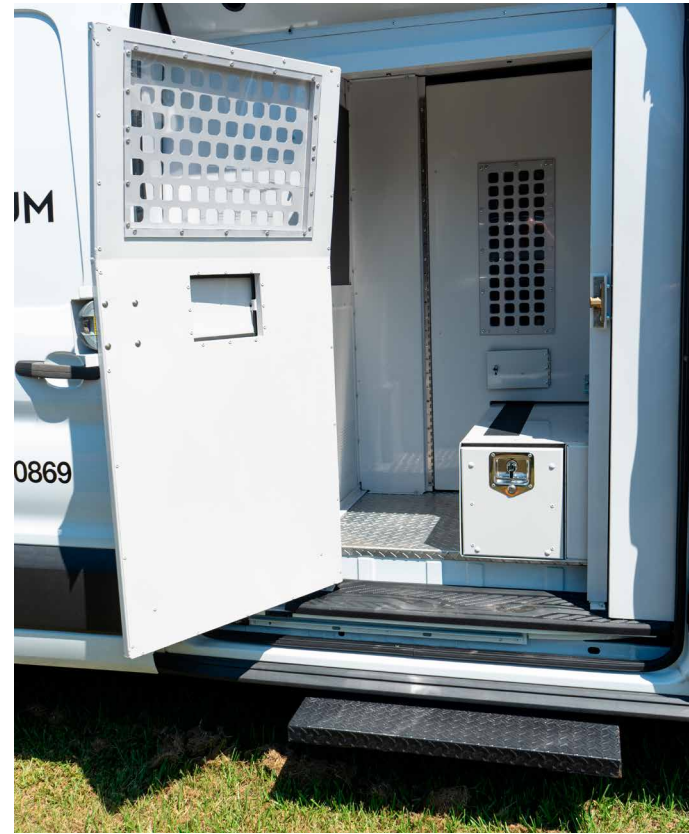

## SCREEN SYSTEMS

Screen systems are available to convert passenger vans into secure inmate transport vehicles. Screen systems are available for Ford Transits and GM 12 and 15 passenger vans that include complete window coverage and front partition.

- 16 gauge galvanized steel window guards
- 0.125" thick aluminum front partition
- 3/16" poly carbonate in partition window
- 1/2" diamonds punched in window guards & 1 1/2" radius squares punched in front partition



COMPLETE WINDOW COVERAGE

Quick install E/Z Security Screen Systems for Ford or GM 12 & 15 Passenger Vans



### SCREEN SYSTEMS

VEHICLE	SCREEN SYSTEM	FRONT PARTITION	MID PARTITION	REAR PARTITION
Transit Low Roof Standard Length	x	x	x	
Transit Low Roof EXT Length	AA-IT-60-018-0	x	x	
Transit Mid Roof Standard Length	x	x	x	x
Transit Mid Roof EXT Length	AA-IT-60-020-0	x	x	x
Transit High Roof Standard Length	x	x	x	x
Transit High Roof EXT Length	AA-IT-60-012-0	x	x	x
Transit Connect	x	x	x	x
Chevy Standard Length	x	x	x	x
Chevy EXT Length	AA-IT-60-021-0	x	x	x



HILLSBOROUGH 5 COMP SKY WHITE ANIMAL CONTROL UNIT

## IN VAN ANIMAL CONTROL UNITS

The In-Van Animal Control unit was designed to fit the top selling cargo vans from Ford Transit, GM, and Dodge. Form-fitted to maximize transport space, designed with the animal control handler in mind, includes secure storage for the officer's gear and made from lightweight, easy to clean aluminum. \*Must be installed at American Aluminum Accessories.

### INCLUDES:

- Insulated walls and ceiling
- Aluminum sheeting of walls and ceiling
- All doors have catch pole perforations for easy access
- AC vent into each cage
- Drain in each cage
- All locks keyed the same
- Folding t handle locks
- LED lighting
- Removable pan in each cage
- Bottom cages have 3/4" perforations
- Top cages have 1/4" perforations
- Lockable storage compartment behind bulkhead
- Diamond plate floor
- Polycarbonate covered window on the center of the bulkhead
- \*\*Rear passenger cage top and bottom is accessible from inside the van



## HIGH QUALITY ANIMAL CONTROL PRODUCTS

American Aluminum manufactures two high quality Animal Control product lines: slide-in truck bed units and in-van animal control units. Made from high quality aluminum, the units are lightweight, which promotes fuel economy and will never rust, providing years of dependable service. The rugged aluminum can handle anything your animals try to do to escape and the floor drains in each compartment allow for easy cleaning.

The last thing you need when handling a stray animal is fighting with your transport vehicle. Attention to

detail is a trademark at American Aluminum and we have designed in features that AC officers have told us helps them do their jobs. The craftsmanship is evident in the custom fit and ease of use for the animal control officer. Every element of the design is tested before the vehicle is released by production and reviewed by customer service before you are notified the vehicle is ready for service.

## TRUCK SLIDE-IN ANIMAL CONTROL UNITS

The Animal Control Slide-in unit is designed to fit into the bed of a pick-up truck which instantly converts the vehicle into an Animal Control Unit. The high grade aluminum means the unit will be in service for many years and can be re-installed into a new vehicle for years and years of service from the unit. The unit includes secure storage for the officer's gear. Constructed from lightweight, easy to clean aluminum, the individual animal compartments have drains for easy cleaning, fans in each compartment, protected LED lighting, heavy duty nontoxic rubber liner, powder coated WHITE, top rail, all lockable compartments, all locks keyed the same, catch pole in each door.



### INCLUDES:

- Protected fans
- Protected interior LED lighting
- Drain in each compartment
- Heavy duty non toxic rubber mat
- Powder coated white
- Top rail
- All lockable compartments
- All locks keyed the same
- Catch pole hole in each door



**HILLSBOROUGH 5 COMP SKY WHITE ANIMAL CONTROL UNIT**

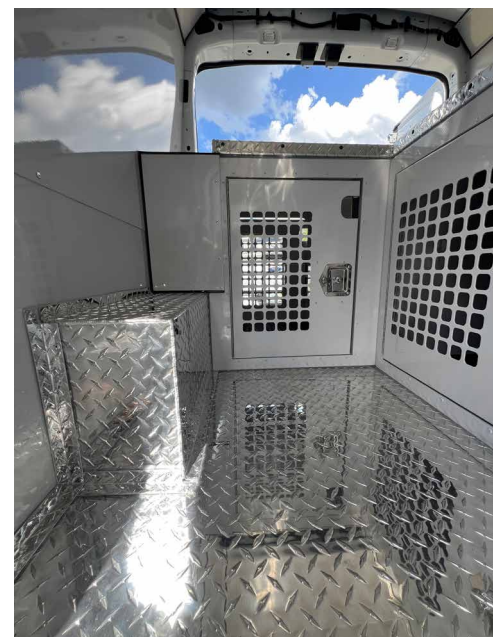
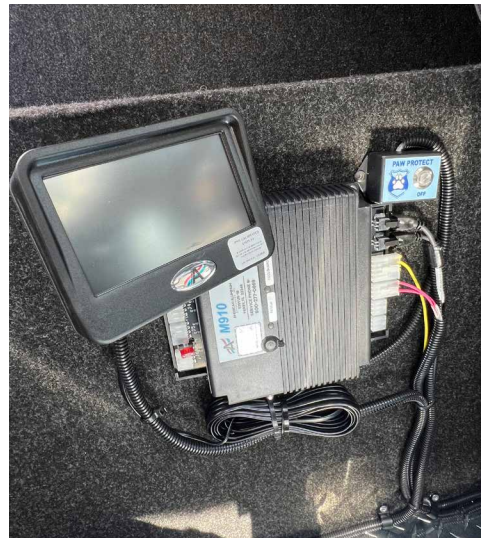

**ANIMAL CONTROL PRODUCTS**

PRODUCT NUMBER	DESCRIPTION
AA-AC-00-116	ANIMAL CONTROL-TRAINING AID-SMALL MAGNETIC SCENT BOX
AA-AC-10-100-1	SWAT-CUSTOM SWAT VAN FOR PINELLAS PAR PD
AA-AC-10-101	SWAT-TREAD PLATE FLOOR FOR SWAT VAN
AA-AC-10-101-3	ANIMAL CONTROL-FORD LOW TRANIST-10 COMP-TELEGRAY
AA-AC-10-400-0	2021-CURRENT FORD TRANISIT HIGH ROOF 4 COMP AC BARE FINISH W/BASKET
AA-AC-11-800-3	ANIMAL CONTROL-8 COMP CHEVY EXPRESS 135" WB ANIMAL CONTROL UNIT
AA-AC-14-100-3	ANIMAL CONTROL-10 COMP-TELEGRAY
AA-AC-14-105-0	INMATE TRANSPORT 10 COMP ANIMAL CONTROL W/30' BOXES BARE FINISH
AA-AC-14-500-0	ANIMAL CONTROL-HILLSBOROUGH-5 COMP BARE FINISH
AA-AC-14-600-3	ANIMAL CONTROL-6 COMP ANIMAL CONTROL FAIRFAX STYLE
AA-AC-14-700-3	ANIMAL CONTROL-7 COMP ANIMAL CONTROL UNIT
AA-AC-14-701-3	ANIMAL CONTROL-CUSTOM 7 COMP ANIMAL CONTROL
AA-AC-14-800-0	ANIMAL CONTROL-8 COMP CHEVY EXTENDED ANIMAL CONTROL UNIT W/FILLERS AND DRIVER SEPARATIONBARE FINISH
AA-AC-14-801-0	ANIMAL CONTROL-8 COMP CHEVY STANDARD ANIMAL CONTROL UNIT W/FILLERS AND DRIVER SEPARATION BARE FINISH
AA-AC-14-802-3	ANIMAL CONTROL-8COMP PRINCE WILLIAMS STYLE-LARGER CATCH POLE HOLES-RAMP-SIDE DOOR GATE
AA-AC-14-810-5	ANIMAL CONTROL-PRINCE WILLIAMS CUSTOM 8 COMP LWB W/STORAGE BOX AND BASKET SKY WHITE
AA-AC-14-900-3	ANIMAL CONTROL-CHARLOTTE STYLE-9 COMP WITH COOLGUARD AND PAGER- TELEGRAY
AA-AC-50-402-5	ANIMAL CONTROL-4 COMP ANIMAL CONTROL SLIDE IN FOR 2015-CURRENT F250
AA-AC-50-601-5	ANIMAL CONTROL-FORD F250 2015-C-6 COMP-WHITE
AA-AC-54-400-5	ANIMAL CONTROL-4 COMP ANIMAL CONTROL SLIDE IN FOR PICK-UP TRUCKS
AA-AC-54-401-5	ANIMAL CONTROL-4 COMP ANIMAL CONTROL SLIDE IN FOR PICK-UP TRUCKS
AA-AC-54-600-5	ANIMAL CONTROL-6 COMP ANIMAL CONTROL SLIDE IN FOR PICK-UP TRUCK
AA-AC-54-601-3	ANIMAL CONTROL-6 COMP CITY OF TALLAHASSEE STYLE ANIMAL CONTROL

## JUMPS PRODUCT NUMBER: AA-AC-00-102-0

BRICK WALL, WHITE WALL, GREEN WALL, CHAIN LINK, WINDOW JUMP, PICKET FENCE, BROAD JUMPS



- Brick wall, white wall & green wall are powder coated, certified ASTM B117-09 to exceed 2,000 hrs of salt water spray testing.
- All aluminum panels measure 48"W x 35"H x 1 1/4" thick. Stand adds 1" to the height.
- Polycarbonate top guard is 1/8" thick.
- Chain link Fence, Polycarbonate side panels are 1/8" thick (1 on each side). Aluminum frame and chain link fence inside.
- 1 1/4" thick. Polycarbonate top guard is 1/8" thick.
- Window Jump is powder coated white. Window sits vertically from ground. Polycarbonate top guard around window.
- Picket fence, 1/2" PVC picket slats on 1 1/8" aluminum panel. 1 1/2" thick. Polycarbonate top guard on top.
- Broad jumps (Hurdles) set of 4, aluminum frame with 1/2" PVC guards across top.

## OBSTACLES PRODUCT NUMBER: AA-AC-00-103-0

CRAWL, A FRAME, CAT WALK



- Crawl is 4 ft wide x 16" tall x 8 ft long. Top is 2" thick diamond plate aluminum panel, interior bracing, simulated lattice sides.
- A Frame is 4 ft wide x 6 ft tall. 3 ft landing deck on one side attached to a 45 degree ramp. Aluminum structure covered with white PVC and non abrasive safety walk. A Frame angle can be expand to a larger angle for novice training.
- Cat Walk, 6 ft tall x 8 ft long x 2 ft wide. 2 ft wide handler's deck mounted on side. Aluminum frame work, running surfaces, 1/3" PVC covered with non abrasive safety walk.
- Ladder at one end with removable safety panel for novice training. 10 ft ramp at opposite end set at 4 degree angle.

## MILITARY COURSE PRODUCT NUMBER: AA-AC-00-104-0



- Hurdles (set of three) are 48" wide and 36" tall with three fixed horizontal slats and three slats which are removable. This allows for the hurdle to be adjusted to heights of 18", 24", 30" or 36".
- A Frame is constructed of non slip materials. Cleats are included for traction/safety. Can be adjusted in height to a max of 6 ft in increments of 1/2". Support chains on each side of the A frame as well as a way of adjusting the A frame height.
- Dog Walk, 12 ft narrow, level walk and narrow decline ramp. Constructed of non-slip vinyl material with cleats for safety of the K9.
- Double Stairway, 8' height and 24' in length. Constructed of non-slip material.
- The window obstacle has removable slats which allow for the obstacle to be set at 18", 24", 30" or 36". Top section slats are fixed at 73".
- Tunnel Crawl is 18" in diameter and 8' in length.
- Barrel: 24"Dx35" • 24"D x 70" • 24"D x 105"L



## CAMLOCKER: TABLE OF CONTENTS

CamLocker Exclusive Features.....	52	King Size Xtra Deep & Tall.....	67
Crossover Truck Toolbox.....	54	CamLocker HD.....	68
How to Measure CamLocker Toolboxes ...	54	Recreational Vehicle (RV) Box.....	70
Crossover Truck Toolbox Variations.....	55	Sidemount Boxes.....	72
Standard/Classic.....	56	SxS (UTV) Boxes.....	74
Slimline & King Slimline.....	60	Side Mount & Underbody Boxes.....	76
King Size.....	62	Hunting Accessories.....	77
Deep & Tall.....	66	Crossover: Make & Model Fit Guide.....	78

### CamLocker Toolboxes are made of heavy duty aluminum and use a unique “cam-lock” mechanism to keep your tools secure.

The boxes are hand crafted in the USA with attention to detail. The full length lid inserted with insulation out-performs all other truck tool box lids.

The interior is felt lined throughout the tub of the box including the bottom for easy cleaning, a convenient sliding tray makes storing your small hand tools easily accessible and heavy-duty shocks allow for a smooth but firm opening and closing of the lid. Camlocker products come with a 3 year structural and 1 year on parts and powdercoat warranty.



### Enhance your CamLocker Toolbox with Integrated L-Track Tie-Down Rails.

Made for secure cargo management and versatile load anchoring.

Designed for durability and flexibility, this accessory provides multiple attachment points for securing equipment, tools, coolers, and cargo during transport.



### FINISHES AVAILABLE:

POLISHED ALUMINUM, GLOSS BLACK, OR MATTE BLACK POWDER COATED

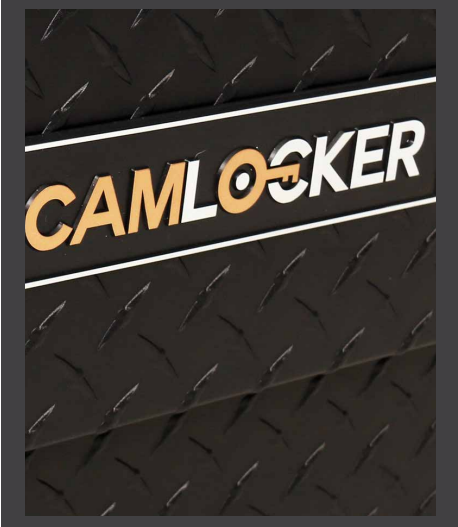
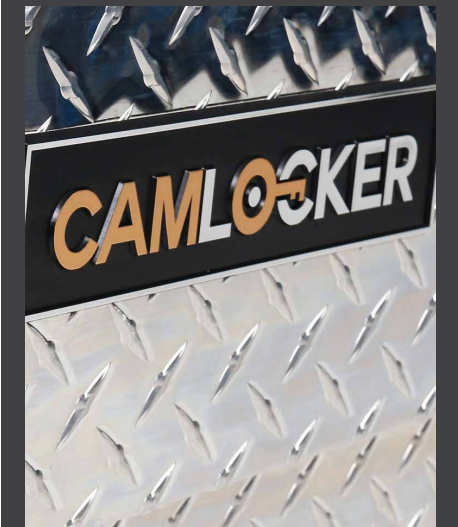

**CAMLOCKER™**  
TOOLBOXES

**HIGH QUALITY ALUMINUM  
TOOLBOXES & TRUCK  
ACCESSORIES**

**WE TAKE PRIDE IN SUPPLYING THE BEST ALUMINUM  
TOOLBOXES AND ACCESSORIES ON THE MARKET.**

We supply American Hand Crafted, high quality aluminum toolboxes and truck accessories throughout the United States. Our exclusively designed aluminum tool boxes and accessories come with carbon steel, hefty chrome plated t-handles, insulated lids and felt lined boxes with tool trays.

**AVAILABLE ON NEW CAMLOCKER TOOLBOX ORDERS**

## CAMLOCKER EXCLUSIVE FEATURES:



**3 Year Warranty Structural**  
**1 Year Warranty Parts and Powder Coat**



**CamLock Locking Mechanism with a Non-Duplicable Key System**  
keeps tools locked securely

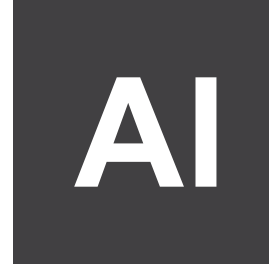

**Heavy Duty Polished Aluminum Welded Construction**



**Insulated and Weather-Sealed Lids** Outperform All Others

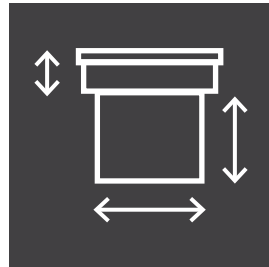

**Available in a Variety of Sizes and Profiles**



**Polished Aluminum or Top-Rated Powder Coat Finish**  
(Matte or Gloss Black)



**T-Handles with Full-Length Continuous Stainless Steel Hinges** Open from Either Side for easy access to your tools

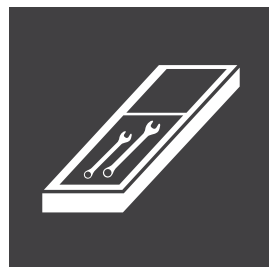

Comes with **Removable, Sliding Tool Tray** for Quick Access to Small Tools



**Completely Carpeted Throughout Sides and Floor**  
Prevents Sliding



THE ULTIMATE IN

**QUALITY**

AMERICAN-MADE





## CROSSOVER TRUCK TOOLBOX

Designed for the buyer who has the need for additional storage but doesn't want to compromise the style of their truck.

With chrome plated carbon steel T-Handles and a proprietary locking mechanism, the CamLocker is

tough and good looking. Manufactured in the USA with stringent quality standards and designed by folks who use the product.

CamLocker is the toolbox of choice for those discriminating buyers who value both style and substance.

### PRODUCT DETAILS

- 3 year structural / 1 year parts and powder coat warranty
- Heavy duty aluminum fully welded for maximum durability
- Locking t-handles with non-duplicable locks
- Camlocking mechanism connecting rods allows for convenient operation from driver or passenger side
- Removable tray
- Full length stainless steel hinges
- Multiple sizes available for custom fits
- Polished aluminum or top rated powder coat finish) matte or gloss box
- Easy to install with pre-punched mounting slot, hardware included (NO DRILLING REQUIRED)

### HOW TO MEASURE CAMLOCKER BOXES

To align better with our Team GJ family, there is new terminology for how we refer to CamLocker measurements.

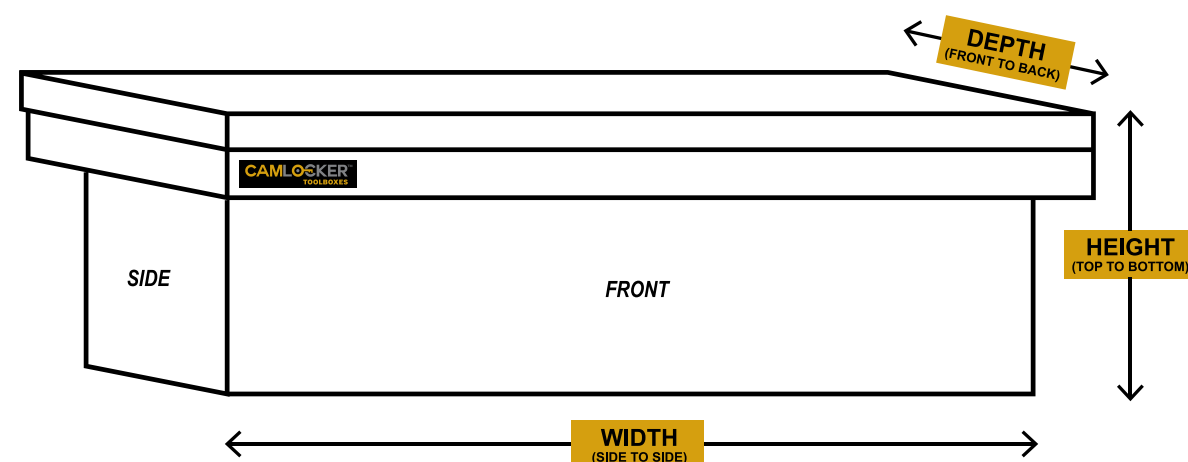

## CROSSOVER TRUCK TOOLBOX VARIATIONS



### STANDARD/CLASSIC

- 6" Above Bed
- Available in **HD**

### SLIMLINE

- 6" Above Bed
- 14" Deep (front to back)
- 14" Tall (top to bottom)

### KING SLIMLINE

- 6" Above Bed
- 14" Deep (front to back)
- 19" Tall (top to bottom)

### KING

- 6" Above Bed
- 19" Tall (top to bottom)
- Available in **HD**

### DEEP & TALL

- 6" Above Bed
- 24.5" Deep (front to back) 16" Tall (top to bottom)

### XTRA DEEP & TALL

- 6" Above Bed
- 24.5" Deep (front to back) 19" Tall (top to bottom)
- Available in **HD**



### LOW PROFILE

- 3" Above Bed
- Available in **HD**

### SLIMLINE - LOW PROFILE

- 3" Above Bed
- 14" Deep (front to back)
- 14" Tall (top to bottom)

### KING SLIMLINE - LOW PROFILE

- 3" Above Bed
- 14" Deep (front to back)
- 19" Tall (top to bottom)

### KING - LOW PROFILE

- 3" Above Bed
- 19" Tall (top to bottom)
- Available in **HD**

### DEEP & TALL - LOW PROFILE

- 3" Above Bed
- 24.5" Deep (front to back) 16" Tall (top to bottom)

### XTRA DEEP & TALL - LOW PROFILE

- 3" Above Bed
- 24.5" Deep (front to back) 19" Tall (top to bottom)
- Available in **HD**



Forged from **HEAVY DUTY .080 ALUMINUM** for the toughest jobs!

**ENHANCED WEATHERSTRIPPING** blocking all outside elements and adding superior protection for your valuables.

# STANDARD/CLASSIC

Option Available in **HD**

**20" Deep** (front to back), **14" Tall** (top to bottom)

The CamLocker Standard/Classic box is the perfect balance of style and substance. The carpeted interior, removable storage tray, choice of profiles and top-rated powder coat finish provide the style. The superior patented locking mechanism, hefty carbon steel T-Handles and heavy duty aluminum welded construction provide the substance.

This box will turn heads all around and upgrade the image of your truck while providing secure storage to keep your valuables safe. The Classic box comes in various lengths and has profile options to make the fit into any style truck and not sacrifice the storage space.



## Standard Profile (6" off bed rail)

STANDARD/CLASSIC CROSSOVER TOOLBOXES	
PRODUCT NUMBER	DESCRIPTION
<b>54" WIDE</b>	
AA-CL-54-100-0	STANDARD PROFILE-54"-NO FINISH
AA-CL-54-100-1	STANDARD PROFILE-54"-MATTE BLACK
AA-CL-54-100-2	STANDARD PROFILE-54"-GLOSS BLACK
AA-CL-54-101-0	STANDARD PROFILE-54"-W/ RAIL-NO FINISH
AA-CL-54-101-1	STANDARD PROFILE-54"-W/ RAIL-MATTE BLACK
AA-CL-54-101-2	STANDARD PROFILE-54"-W/ RAIL-GLOSS BLACK
<b>60" WIDE</b>	
AA-CL-60-100-0	STANDARD PROFILE-60"-NO FINISH
AA-CL-60-100-1	STANDARD PROFILE-60"-MATTE BLACK
AA-CL-60-100-2	STANDARD PROFILE-60"-GLOSS BLACK
AA-CL-60-101-0	STANDARD PROFILE -60"-W/ RAIL-NO FINISH
AA-CL-60-101-1	STANDARD PROFILE-60"-W/ RAIL-MATTE BLACK
AA-CL-60-101-2	STANDARD PROFILE-60"-W/ RAIL-GLOSS BLACK

AA-CL-60-108-2	STANDARD PROFILE-60"-W/ BEVEL-W/ RAIL-JEEP GLADIATOR-GLOSS BLACK
AA-CL-60-109-0	STANDARD PROFILE-60"-FULL NOTCH-NO FINISH
AA-CL-60-109-1	STANDARD PROFILE-60"-FULL NOTCH-MATTE BLACK
AA-CL-60-109-2	STANDARD PROFILE-60"-FULL NOTCH-GLOSS BLACK
AA-CL-60-110-0	STANDARD PROFILE-60"-FULL NOTCH-W/ RAIL-NO FINISH
AA-CL-60-110-1	STANDARD PROFILE-60"-FULL NOTCH-W/ RAIL-MATTE BLACK
AA-CL-60-110-2	STANDARD PROFILE-60"-FULL NOTCH-W/ RAIL-GLOSS BLACK
AA-CL-60-118-0	STANDARD PROFILE-60"-YORK-NO FINISH
AA-CL-60-118-1	STANDARD PROFILE-60"-YORK-MATTE BLACK
AA-CL-60-118-2	STANDARD PROFILE-60"-YORK-GLOSS BLACK
AA-CL-60-119-0	STANDARD PROFILE-60"-YORK-W/ RAIL-NO FINISH
AA-CL-60-119-1	STANDARD PROFILE-60"-YORK-W/ RAIL-MATTE BLACK
AA-CL-60-119-2	STANDARD PROFILE-60"-YORK-W/ RAIL-GLOSS BLACK
AA-CL-60-120-0	STANDARD PROFILE-60"-YORK-FULL NOTCH-NO FINISH
AA-CL-60-120-1	STANDARD PROFILE-60"-YORK-FULL NOTCH-MATTE BLACK

AA-CL-60-120-2	STANDARD PROFILE-60"-YORK-FULL NOTCH-GLOSS BLACK
AA-CL-60-121-0	STANDARD PROFILE-60"-YORK-FULL NOTCH-W/ RAIL-NO FINISH
AA-CL-60-121-1	STANDARD PROFILE-60"-YORK-FULL NOTCH-W/ RAIL-MATTE BLACK
AA-CL-60-121-2	STANDARD PROFILE-60"-YORK-FULL NOTCH-W/ RAIL-GLOSS BLACK
<b>63" WIDE</b>	
AA-CL-63-100-0	STANDARD PROFILE -63"-NO FINISH
AA-CL-63-100-1	STANDARD PROFILE -63"-MATTE BLACK
AA-CL-63-100-2	STANDARD PROFILE-63"-GLOSS BLACK
AA-CL-63-101-0	STANDARD PROFILE-63"-W/ RAIL-NO FINISH
AA-CL-63-101-1	STANDARD PROFILE-63"-W/ RAIL-MATTE BLACK
AA-CL-63-101-2	STANDARD PROFILE-63"-W/ RAIL-GLOSS BLACK
AA-CL-63-107-0	STANDARD PROFILE-63"-FULL NOTCH-NO FINISH
AA-CL-63-107-1	STANDARD PROFILE-63"-FULL NOTCH-MATTE BLACK
AA-CL-63-107-2	STANDARD PROFILE-63"-FULL NOTCH-GLOSS BLACK
AA-CL-63-108-0	STANDARD PROFILE-63"-FULL NOTCH-W/ RAIL-NO FINISH
AA-CL-63-108-1	STANDARD PROFILE 63"-FULL NOTCH-W/ RAIL-MATTE BLACK
AA-CL-63-108-2	STANDARD PROFILE-63"-FULL NOTCH-W/ RAIL-GLOSS BLACK
<b>65" WIDE</b>	
AA-CL-65-100-0	STANDARD PROFILE-65"-NO FINISH
AA-CL-65-100-1	STANDARD PROFILE-65"-MATTE BLACK
AA-CL-65-100-2	STANDARD PROFILE-65"-GLOSS BLACK
AA-CL-65-101-0	STANDARD PROFILE-65"-W/ RAIL-NO FINISH
AA-CL-65-101-1	STANDARD PROFILE-65"-W/ RAIL-MATTE BLACK
AA-CL-65-101-2	STANDARD PROFILE-65"-W/ RAIL-GLOSS BLACK
AA-CL-65-109-0	STANDARD PROFILE-65"-YORK-NO FINISH
AA-CL-65-109-1	STANDARD PROFILE-65"-YORK-MATTE BLACK
AA-CL-65-109-2	STANDARD PROFILE-65"-YORK-GLOSS BLACK
AA-CL-65-110-0	STANDARD PROFILE-65"-YORK-W/ RAIL-NO FINISH
AA-CL-65-110-1	STANDARD PROFILE-65"-YORK-W/ RAIL-MATTE BLACK
AA-CL-65-110-2	STANDARD PROFILE-65"-YORK-W/ RAIL-GLOSS BLACK

AA-CL-65-111-0	STANDARD PROFILE-65"-YORK-FULL NOTCH-NO FINISH
AA-CL-65-111-1	STANDARD PROFILE-65"-YORK-FULL NOTCH-MATTE BLACK
AA-CL-65-111-2	STANDARD PROFILE-65"-YORK-FULL NOTCH-GLOSS BLACK
AA-CL-65-112-0	STANDARD PROFILE-65"-YORK-FULL NOTCH-W/ RAIL-NO FINISH
AA-CL-65-112-1	STANDARD PROFILE-65"-YORK-FULL NOTCH-W/ RAIL-MATTE BLACK
AA-CL-65-112-2	STANDARD PROFILE-65"-YORK-FULL NOTCH-W/ RAIL-GLOSS BLACK
<b>67" WIDE</b>	
AA-CL-67-100-0	STANDARD PROFILE-67"-NO FINISH
AA-CL-67-100-1	STANDARD PROFILE-67"-MATTE BLACK
AA-CL-67-100-2	STANDARD PROFILE-67"-GLOSS BLACK
AA-CL-67-101-0	STANDARD PROFILE-67"-W/ RAIL-NO FINISH
AA-CL-67-101-1	STANDARD PROFILE-67"-W/ RAIL-MATTE BLACK
AA-CL-67-101-2	STANDARD PROFILE-67"-W/ RAIL-GLOSS BLACK
<b>70" WIDE</b>	
AA-CL-70-100-0	STANDARD PROFILE-70"-NO FINISH
AA-CL-70-100-1	STANDARD PROFILE-70"-MATTE BLACK
AA-CL-70-100-2	STANDARD PROFILE-70"-GLOSS BLACK
AA-CL-70-101-0	STANDARD PROFILE-70"-W/ RAIL-NO FINISH
AA-CL-70-101-1	STANDARD PROFILE-70"-W/ RAIL-MATTE BLACK
AA-CL-70-101-2	STANDARD PROFILE-70"-W/ RAIL-GLOSS BLACK
<b>71" WIDE</b>	
AA-CL-71-100-0	STANDARD PROFILE 71" - NO FINISH
AA-CL-71-100-1	STANDARD PROFILE-71"-MATTE BLACK
AA-CL-71-100-2	STANDARD PROFILE-71"-GLOSS BLACK
AA-CL-71-101-0	STANDARD PROFILE-71"-W/ RAIL-NO FINISH
AA-CL-71-101-1	STANDARD PROFILE-71"-W/ RAIL-MATTE BLACK
AA-CL-71-101-2	STANDARD PROFILE-71"-W/ RAIL-GLOSS BLACK

**Low Profile (3" off bed rail)**

LOW PROFILE STANDARD/CLASSIC CROSSOVER TOOLBOXES	
PRODUCT NUMBER	DESCRIPTION
<b>54" WIDE</b>	
AA-CL-54-103-0	54"-LOW PROFILE-NO FINISH
AA-CL-54-103-1	54"-LOW PROFILE-MATTE BLACK
AA-CL-54-103-2	54"-LOW PROFILE-GLOSS BLACK
AA-CL-54-104-0	54"-LOW PROFILE-W/ RAIL-NO FINISH
AA-CL-54-104-1	54"-LOW PROFILE-W/ RAIL-MATTE BLACK
AA-CL-54-104-2	54"-LOW PROFILE-W/ RAIL-GLOSS BLACK
AA-CL-54-105-0	54"-LOW PROFILE-FULL NOTCH-NO FINISH
AA-CL-54-105-1	54"-LOW PROFILE-FULL NOTCH-MATTE BLACK
AA-CL-54-105-2	54"-LOW PROFILE-FULL NOTCH-GLOSS BLACK
AA-CL-54-106-0	54"-LOW PROFILE-FULL NOTCH-W/ RAIL-NO FINISH
AA-CL-54-106-1	54"-LOW PROFILE-FULL NOTCH-W/ RAIL-MATTE BLACK
AA-CL-54-106-2	54"-LOW PROFILE-FULL NOTCH-W/ RAIL-GLOSS BLACK
AA-CL-54-107-1	54"-LOW PROFILE-YORK-FULL NOTCH-MATTE BLACK
AA-CL-54-107-2	54"-LOW PROFILE-YORK-FULL NOTCH-GLOSS BLACK
<b>60" WIDE</b>	
AA-CL-60-111-0	60"-LOW PROFILE-NO FINISH
AA-CL-60-111-1	60"-LOW PROFILE-MATTE BLACK
AA-CL-60-111-2	60"-LOW PROFILE-GLOSS BLACK
AA-CL-60-112-0	60"-LOW PROFILE-W/ RAIL-NO FINISH
AA-CL-60-112-1	60"-LOW PROFILE-W/ RAIL-MATTE BLACK
AA-CL-60-112-2	60"-LOW PROFILE-W/ RAIL-GLOSS BLACK
AA-CL-60-113-0	60"-LOW PROFILE-W/ BEVEL-JEEP GLADIATOR-NO FINISH
AA-CL-60-113-1	60"-LOW PROFILE-W/ BEVEL-JEEP GLADIATOR-MATTE BLACK
AA-CL-60-113-2	60"-LOW PROFILE-W/ BEVEL-JEEP GLADIATOR-GLOSS BLACK
AA-CL-60-114-0	60"-LOW PROFILE-W/ BEVEL-W/ RAIL-JEEP GLADIATOR-NO FINISH
AA-CL-60-114-1	60"-LOW PROFILE-W/ BEVEL-W/ RAIL-JEEP GLADIATOR-MATTE BLACK
AA-CL-60-114-2	60"-LOW PROFILE-W/ BEVEL-W/ RAIL-JEEP GLADIATOR-GLOSS BLACK
AA-CL-60-115-0	60"-16" WIDE-LOW PROFILE-W/ BEVEL-W/ RAIL-JEEP GLADIATOR-NO FINISH

AA-CL-60-116-0	60"-LOW PROFILE-FULL NOTCH-NO FINISH
AA-CL-60-116-1	60"-LOW PROFILE-FULL NOTCH-MATTE BLACK
AA-CL-60-116-2	60"-LOW PROFILE-FULL NOTCH-GLOSS BLACK
AA-CL-60-117-0	60"-LOW PROFILE-FULL NOTCH-W/ RAIL-NO FINISH
AA-CL-60-117-1	60"-LOW PROFILE-FULL NOTCH-W/ RAIL-MATTE BLACK
AA-CL-60-117-2	60"-LOW PROFILE-FULL NOTCH-W/ RAIL-GLOSS BLACK
AA-CL-60-122-0	60"-YORK-LOW PROFILE-NO FINISH
AA-CL-60-122-1	60"-YORK-LOW PROFILE-MATTE BLACK
AA-CL-60-122-2	60"-YORK-LOW PROFILE-GLOSS BLACK
AA-CL-60-123-0	60"-YORK-LOW PROFILE-W/ RAIL-NO FINISH
AA-CL-60-124-0	60"-YORK-LOW PROFILE-FULL NOTCH-NO FINISH
AA-CL-60-124-1	60"-YORK-LOW PROFILE-FULL NOTCH-MATTE BLACK
AA-CL-60-124-2	60"-YORK-LOW PROFILE-FULL NOTCH-GLOSS BLACK
AA-CL-60-125-0	60"-YORK-LOW PROFILE-FULL NOTCH-W/ RAIL-NO FINISH
AA-CL-60-125-1	60"-YORK-LOW PROFILE-FULL NOTCH-W/ RAIL-MATTE BLACK
AA-CL-60-125-2	60"-YORK-LOW PROFILE-FULL NOTCH-W/ RAIL-GLOSS BLACK
<b>63" WIDE</b>	
AA-CL-63-109-0	63"-LOW PROFILE-NO FINISH
AA-CL-63-109-1	63"-LOW PROFILE-MATTE BLACK
AA-CL-63-109-2	63"-LOW PROFILE-GLOSS BLACK
AA-CL-63-111-0	63"-LOW PROFILE-W/ RAIL-NO FINISH
AA-CL-63-111-1	63"-LOW PROFILE-W/ RAIL-MATTE BLACK
AA-CL-63-111-2	63"-LOW PROFILE-W/ RAIL-GLOSS BLACK
AA-CL-63-112-0	63"-LOW PROFILE-FULL NOTCH-NO FINISH
AA-CL-63-112-1	63" LOW PROFILE-FULL NOTCH-MATTE BLACK
AA-CL-63-112-2	63"-LOW PROFILE-FULL NOTCH-GLOSS BLACK
AA-CL-63-114-0	63"-LOW PROFILE-FULL NOTCH-W/ RAIL-NO FINISH
AA-CL-63-114-1	63"-LOW PROFILE-FULL NOTCH-W/ RAIL-MATTE BLACK
AA-CL-63-114-2	63"-LOW PROFILE-FULL NOTCH-W/ RAIL-GLOSS BLACK
<b>65" WIDE</b>	

AA-CL-65-107-0	65"-LOW PROFILE-NO FINISH
AA-CL-65-107-1	65"-LOW PROFILE-MATTE BLACK
AA-CL-65-107-2	65"-LOW PROFILE-GLOSS BLACK
AA-CL-65-108-0	65"-LOW PROFILE-W/ RAIL-NO FINISH
AA-CL-65-108-1	65"-LOW PROFILE-W/ RAIL-MATTE BLACK
AA-CL-65-108-2	65"-LOW PROFILE-W/ RAIL-GLOSS BLACK
AA-CL-65-113-0	65"-YORK-LOW PROFILE-NO FINISH
AA-CL-65-113-1	65"-YORK-LOW PROFILE-MATTE BLACK
AA-CL-65-113-2	65"-YORK-LOW PROFILE-GLOSS BLACK
AA-CL-65-114-0	65"-YORK-LOW PROFILE-W/ RAIL-NO FINISH
AA-CL-65-114-1	65"-YORK-LOW PROFILE-W/ RAIL-MATTE BLACK
AA-CL-65-114-2	65"-YORK-LOW PROFILE-W/ RAIL-GLOSS BLACK
AA-CL-65-115-0	65"-YORK-LOW PROFILE-FULL NOTCH-NO FINISH
AA-CL-65-115-1	65"-YORK-LOW PROFILE-FULL NOTCH-MATTE BLACK
AA-CL-65-115-2	65"-YORK-LOW PROFILE-FULL NOTCH-GLOSS BLACK
AA-CL-65-116-0	65"-YORK-LOW PROFILE-FULL NOTCH-W/ RAIL-NO FINISH
AA-CL-65-116-1	65"-YORK-LOW PROFILE-FULL NOTCH-W/ RAIL-MATTE BLACK
AA-CL-65-116-2	65"-YORK-LOW PROFILE-FULL NOTCH-W/ RAIL-GLOSS BLACK
<b>67" WIDE</b>	
AA-CL-67-102-0	67"-LOW PROFILE-NO FINISH
AA-CL-67-102-1	67"-LOW PROFILE-MATTE BLACK
AA-CL-67-102-2	67"-LOW PROFILE-GLOSS BLACK
AA-CL-67-103-0	67"-LOW PROFILE-W/ RAIL-NO FINISH
AA-CL-67-103-1	67"-LOW PROFILE-W/ RAIL-MATTE BLACK
AA-CL-67-103-2	67"-LOW PROFILE-W/ RAIL-GLOSS BLACK
AA-CL-67-104-0	67"-LOW PROFILE-FULL NOTCH-NO FINISH
AA-CL-67-104-1	67"-LOW PROFILE-FULL NOTCH-MATTE BLACK
AA-CL-67-104-2	67"-LOW PROFILE-FULL NOTCH-GLOSS BLACK
AA-CL-67-105-0	67"-LOW PROFILE-FULL NOTCH-W/ RAIL-NO FINISH

AA-CL-67-105-1	67"-LOW PROFILE-FULL NOTCH-W/ RAIL-MATTE BLACK
AA-CL-67-105-2	67"-LOW PROFILE-FULL NOTCH-W/ RAIL-GLOSS BLACK
<b>69" WIDE</b>	
AA-CL-69-102-0	69"-LOW PROFILE-NO FINISH
AA-CL-69-102-1	69"-LOW PROFILE-MATTE BLACK
AA-CL-69-103-1	69"-LOW PROFILE-W/ RAIL-MATTE BLACK
<b>70" WIDE</b>	
AA-CL-70-102-0	70"-LOW PROFILE-NO FINISH
AA-CL-70-102-1	70"-LOW PROFILE-MATTE BLACK
AA-CL-70-102-2	70"-LOW PROFILE-GLOSS BLACK
AA-CL-70-103-0	70"-LOW PROFILE-W/ RAIL-NO FINISH
AA-CL-70-103-1	70"-LOW PROFILE-W/ RAIL-MATTE BLACK
AA-CL-70-103-2	70"-LOW PROFILE-W/ RAIL-GLOSS BLACK
<b>71" WIDE</b>	
AA-CL-71-115-0	71"-LOW PROFILE-NO FINISH
AA-CL-71-115-1	71"-LOW PROFILE-MATTE BLACK
AA-CL-71-115-2	71"-LOW PROFILE-GLOSS BLACK
AA-CL-71-119-0	71"-LOW PROFILE-W/ RAIL-NO FINISH
AA-CL-71-119-1	71"-LOW PROFILE-W/ RAIL-MATTE BLACK
AA-CL-71-119-2	71"-LOW PROFILE-W/ RAIL-GLOSS BLACK
AA-CL-71-121-0	71"-LOW PROFILE-UNIVERSAL NOTCH-NO FINISH
AA-CL-71-121-1	71"-LOW PROFILE-UNIVERSAL NOTCH-MATTE BLACK
AA-CL-71-121-2	71"-LOW PROFILE-UNIVERSAL NOTCH-GLOSS BLACK
AA-CL-71-122-0	71"-LOW PROFILE-UNIVERSAL NOTCH-W/ RAIL-NO FINISH
AA-CL-71-122-1	71"-LOW PROFILE-UNIVERSAL NOTCH-W/ RAIL-MATTE BLACK
AA-CL-71-122-2	71"-LOW PROFILE-UNIVERSAL NOTCH-W/ RAIL-GLOSS BLACK
AA-CL-71-195-0	71" LOW PROFILE W/ RAIL NO FINISH
AA-CL-71-195-1	71" LOW PROFILE W/ RAIL MATTE BLACK
AA-CL-71-195-2	71" LOW PROFILE W/ RAIL GLOSS BLACK

# SLIMLINE & KING SLIMLINE

**Slimline: 14" Deep** (front to back), **14" Tall** (top to bottom)

**King Slimline: 14" Deep, 19" Tall**

With today's rise in the popularity of Crew Cabs and other extended cabs, the cargo beds continue to get smaller and smaller. This series is perfect for lockable protection without sacrificing your bed space.

This model comes in at the standard height of 14", top to bottom, (lid included) but with a reduced depth, front to back -14" instead of the standard 20". Available in all series. The KSL has the same features but provides the same height as our King Size model at 19", top to bottom (lid included).



While the Slimline models are designed for shorter bed lengths our unique notching system is still available to accommodate appropriate fit.

## Standard Profile (6" off bed rail)

SLIMLINE & KING SLIMLINE CROSSOVER TOOLBOXES	
PRODUCT NUMBER	DESCRIPTION
<b>54" WIDE</b>	
AA-CL-54-500-1	SLIM-54"-MATTE BLACK
<b>60" WIDE</b>	
AA-CL-60-502-0	STANDARD 60 SLIM LINE W/RAIL
AA-CL-60-502-1	STANDARD 60 SLIM LINE W/RAIL MATTE BLACK
AA-CL-60-502-2	STANDARD 60 SLIM LINE W/RAIL GLOSS BLACK
AA-CL-60-503-1	SLIM-60"-MATTE BLACK
AA-CL-60-504-1	SLIM-60"-W/ BEVEL-W/ RAIL-JEEP GLADIATOR-MATTE BLACK
AA-CL-60-513-0	SLIM-60"-YORK-FULL NOTCH-12" WIDE-NO FINISH
<b>63" WIDE</b>	
AA-CL-63-500-0	SLIM-63"-NO FINISH
AA-CL-63-500-1	SLIM-63"-MATTE BLACK
AA-CL-63-500-2	SLIM-63"-GLOSS BLACK
AA-CL-63-502-0	SLIM-63"-W/ RAIL-NO FINISH
AA-CL-63-502-1	SLIM-63"-W/ RAIL-MATTE BLACK

AA-CL-63-502-2	SLIM-63"-W/ RAIL-GLOSS BLACK
AA-CL-63-503-1	SLIM-63"-FULL NOTCH-MATTE BLACK
<b>65" WIDE</b>	
AA-CL-65-500-0	SLIM-65"-NO FINISH
AA-CL-65-500-1	SLIM-65"-MATTE BLACK
AA-CL-65-209-1	KING SIZE-65"-STANDARD PROFILE-14" WIDE-YORK-MATTE BLACK
<b>69" WIDE</b>	
AA-CL-69-500-1	SLIM-69"-MATTE BLACK
<b>71" WIDE</b>	
AA-CL-71-246-1	KING SIZE-71" SLIM LINE LOW PROFILE-MATTE BLACK
AA-CL-71-500-0	71" STANDARD PROFILE SLIM LINE NO FINISH
AA-CL-71-500-1	71" STANDARD PROFILE SLIM LINE MATTE BLACK
AA-CL-71-500-2	71" STANDARD PROFILE SLIM LINE-GLOSS BLACK
AA-CL-71-502-0	SLIM-71"-W/ RAIL-NO FINISH
AA-CL-71-502-1	SLIM-71"-W/ RAIL-MATTE BLACK
AA-CL-71-502-2	SLIM-71"-W/ RAIL-GLOSS BLACK

## Low Profile (3" off bed rail)

LOW PROFILE SLIMLINE & KING SLIMLINE CROSSOVER TOOLBOXES	
PRODUCT NUMBER	DESCRIPTION
<b>54" WIDE</b>	
AA-CL-54-501-1	SLIM-54"-LOW PROFILE-MATTE BLACK
AA-CL-54-502-0	54 LOW PROFILE SLIM LINE W/ RAIL NO FINISH
AA-CL-54-502-1	54 LOW PROFILE SLIM LINE W/ RAIL MATTE BLACK
AA-CL-54-502-2	54 LOW PROFILE SLIM LINE W/ RAIL GLOSS BLACK
<b>60" WIDE</b>	
AA-CL-60-505-0	SLIM-60"-LOW PROFILE-NO FINISH
AA-CL-60-505-1	SLIM-60"-LOW PROFILE-MATTE BLACK
AA-CL-60-505-2	SLIM-60"-LOW PROFILE-GLOSS BLACK
AA-CL-60-506-1	SLIM-60"-LOW PROFILE-W/ BEVEL-MATTE BLACK
AA-CL-60-507-1	SLIM-60"-LOW PROFILE-W/ BEVEL-W/ RAIL-MATTE BLACK
AA-CL-60-508-0	SLIM-60"-LOW PROFILE-W/ RAIL-NO FINISH
AA-CL-60-508-1	SLIM-60"-LOW PROFILE-W/ RAIL-MATTE BLACK
AA-CL-60-508-2	SLIM-60"-LOW PROFILE-W/ RAIL-GLOSS BLACK
AA-CL-60-510-0	SLIM-60"-LOW PROFILE-FULL NOTCH-NO FINISH
AA-CL-60-510-1	SLIM-60"-LOW PROFILE-FULL NOTCH-MATTE BLACK
AA-CL-60-510-2	SLIM-60"-LOW PROFILE-FULL NOTCH-GLOSS BLACK
AA-CL-60-511-0	SLIM-60"-LOW PROFILE-FULL NOTCH-W/ RAIL-NO FINISH
AA-CL-60-511-1	SLIM-60"-LOW PROFILE-FULL NOTCH-W/ RAIL-MATTE BLACK
AA-CL-60-511-2	SLIM-60"-LOW PROFILE-FULL NOTCH-W/ RAIL-GLOSS BLACK
AA-CL-60-513-1	SLIM-60"-YORK-LOW PROFILE-FULL NOTCH-MATTE BLACK
<b>63" WIDE</b>	
AA-CL-63-504-0	SLIM-63"-LOW PROFILE-NO FINISH
AA-CL-63-504-1	SLIM-63"-LOW PROFILE-MATTE BLACK
AA-CL-63-504-2	SLIM-63"-LOW PROFILE-GLOSS BLACK
AA-CL-63-505-0	SLIM-63"-LOW PROFILE-W/ RAIL-NO FINISH
AA-CL-63-505-1	SLIM-63"-LOW PROFILE-W/ RAIL-MATTE BLACK
AA-CL-63-505-2	SLIM-63"-LOW PROFILE-W/ RAIL-GLOSS BLACK

AA-CL-63-506-0	SLIM-63"-LOW PROFILE-FULL NOTCH-NO FINISH
AA-CL-63-506-1	SLIM-63"-LOW PROFILE-FULL NOTCH-MATTE BLACK
AA-CL-63-506-2	SLIM-63"-LOW PROFILE-FULL NOTCH-GLOSS BLACK
AA-CL-63-507-0	SLIM-63"-LOW PROFILE-FULL NOTCH-W/ RAIL-NO FINISH
AA-CL-63-507-1	SLIM-63"-LOW PROFILE-FULL NOTCH-W/ RAIL-MATTE BLACK
AA-CL-63-507-2	SLIM-63"-LOW PROFILE-FULL NOTCH-W/ RAIL-GLOSS BLACK
<b>65" WIDE</b>	
AA-CL-65-501-0	SLIM-65"-YORK-LOW PROFILE-NO FINISH
AA-CL-65-501-1	SLIM-65"-YORK-LOW PROFILE-MATTE BLACK
AA-CL-65-501-2	SLIM-65"-YORK-LOW PROFILE-GLOSS BLACK
AA-CL-65-502-0	SLIM-65"-YORK-LOW PROFILE-W/ RAIL-NO FINISH
AA-CL-65-502-1	SLIM-65"-YORK-LOW PROFILE-W/ RAIL-MATTE BLACK
AA-CL-65-502-2	SLIM-65"-YORK-LOW PROFILE-W/ RAIL-GLOSS BLACK
AA-CL-65-503-0	SLIM-65"-YORK-LOW PROFILE-FULL NOTCH-NO FINISH
AA-CL-65-503-1	SLIM-65"-YORK-LOW PROFILE-FULL NOTCH-MATTE BLACK
AA-CL-65-503-2	SLIM-65"-YORK-LOW PROFILE-FULL NOTCH-GLOSS BLACK
AA-CL-65-504-0	SLIM-65"-YORK-LOW PROFILE-FULL NOTCH-W/ RAIL-NO FINISH
AA-CL-65-504-1	SLIM-65"-YORK-LOW PROFILE-FULL NOTCH-W/ RAIL-MATTE BLACK
AA-CL-65-504-2	SLIM-65"-YORK-LOW PROFILE-FULL NOTCH-W/ RAIL-GLOSS BLACK
AA-CL-65-210-1	KING SIZE-65"-14" WIDE-YORK-LOW PROFILE-FULL NOTCH-MATTE BLACK
<b>67" WIDE</b>	
AA-CL-67-500-0	SLIM-67"-LOW PROFILE-NO FINISH
<b>69" WIDE</b>	
AA-CL-69-500-2	SLIM-69"-LOW PROFILE-GLOSS BLACK
AA-CL-69-501-1	SLIM-69"-LOW PROFILE-W/ RAIL-MATTE BLACK
<b>71" WIDE</b>	
AA-CL-71-246-1	KING SIZE-71" SLIM LINE LOW PROFILE-MATTE BLACK
AA-CL-71-503-0	SLIM LINE-71"-LOW PROFILE-NO FINISH
AA-CL-71-503-1	SLIM LINE-71"-LOW PROFILE-MATTE BLACK
AA-CL-71-503-2	SLIM LINE-71"-LOW PROFILE-GLOSS BLACK
AA-CL-71-505-0	SLIM-71"-LOW PROFILE-W/ RAIL-NO FINISH
AA-CL-71-505-1	SLIM-71"-LOW PROFILE-W/ RAIL-MATTE BLACK
AA-CL-71-505-2	SLIM-71"-LOW PROFILE-W/ RAIL-GLOSS BLACK

# KING SIZE

Option Available in **HD**

**20" Deep** (front to back), **19" Tall** (top to bottom)

### KEY FEATURE:

The King allows you to have 25% more storage space measuring 19" tall, top to bottom, with lid included.



### Standard Profile (6" off bed rail)

KING SIZE CROSSOVER TOOLBOXES	
PRODUCT NUMBER	DESCRIPTION
<b>60" WIDE</b>	
AA-CL-60-200-0	KING SIZE-60"-STANDARD PROFILE - NO FINISH
AA-CL-60-200-1	KING SIZE-60"- STANDARD PROFILE - MATTE BLACK
AA-CL-60-200-2	KING SIZE-60"- STANDARD PROFILE GLOSS BLACK
AA-CL-60-201-0	KING SIZE-60"-STANDARD PROFILE W/ RAIL-NO FINISH
AA-CL-60-201-1	KING SIZE-60"-STANDARD PROFILE W/ RAIL-MATTE BLACK
AA-CL-60-201-2	KING SIZE-60"-STANDARD PROFILE W/ RAIL-GLOSS BLACK
AA-CL-60-202-0	KING SIZE-60"-STANDARD PROFILE-FULL NOTCH-NO FINISH
AA-CL-60-202-1	KING SIZE-60"-STANDARD PROFILE-FULL NOTCH-MATTE BLACK
AA-CL-60-202-2	KING SIZE-60"-STANDARD PROFILE-FULL NOTCH-GLOSS BLACK
<b>63" WIDE</b>	
AA-CL-63-200-0	KING SIZE-63" STANDARD PROFILE -NO FINISH
AA-CL-63-200-1	KING SIZE-63"-STANDARD PROFILE MATTE BLACK
AA-CL-63-200-2	KING SIZE-63"-STANDARD PROFILE-GLOSS BLACK
AA-CL-63-201-0	KING SIZE-63"-STANDARD PROFILE-W/ RAIL-NO FINISH
AA-CL-63-201-1	KING SIZE-63"-STANDARD PROFILE-W/ RAIL-MATTE BLACK
AA-CL-63-201-2	KING SIZE-63"-STANDARD PROFILE-W/ RAIL-GLOSS BLACK
AA-CL-63-204-0	KING SIZE-63"-STANDARD PROFILE-FULL NOTCH-NO FINISH
AA-CL-63-204-1	KING SIZE-63"-STANDARD PROFILE-FULL NOTCH-MATTE BLACK
AA-CL-63-204-2	KING SIZE-63"-STANDARD PROFILE-FULL NOTCH-GLOSS BLACK

AA-CL-63-205-0	KING SIZE-63"-STANDARD PROFILE-FULL NOTCH-W/ RAIL-NO FINISH
AA-CL-63-205-1	KING SIZE-63"-STANDARD PROFILE-FULL NOTCH-W/ RAIL-MATTE BLACK
AA-CL-63-205-2	KING SIZE-63"-STANDARD PROFILE-FULL NOTCH-W/ RAIL-GLOSS BLACK
<b>65" WIDE</b>	
AA-CL-65-200-0	KING SIZE-65"-STANDARD PROFILE-NO FINISH
AA-CL-65-200-1	KING SIZE-65"-STANDARD PROFILE-MATTE BLACK
AA-CL-65-200-2	KING SIZE-65"-STANDARD PROFILE-GLOSS BLACK
AA-CL-65-201-0	KING SIZE-65"-STANDARD PROFILE-W/ RAIL-NO FINISH
AA-CL-65-201-1	KING SIZE-65"-STANDARD PROFILE-W/ RAIL-MATTE BLACK
AA-CL-65-201-2	KING SIZE-65"-STANDARD PROFILE-W/ RAIL-GLOSS BLACK
AA-CL-65-204-0	KING SIZE-65"-STANDARD PROFILE-YORK-FULL NOTCH-NO FINISH
AA-CL-65-204-1	KING SIZE-65"-STANDARD PROFILE-YORK-FULL NOTCH-MATTE BLACK
AA-CL-65-204-2	KING SIZE-65"-STANDARD PROFILE-YORK-FULL NOTCH-GLOSS BLACK
AA-CL-65-206-0	KING SIZE-65"-STANDARD PROFILE-YORK-FULL NOTCH-W/ RAIL-NO FINISH
AA-CL-65-206-1	KING SIZE-65"-STANDARD PROFILE-YORK-FULL NOTCH-W/ RAIL-MATTE BLACK
AA-CL-65-206-2	KING SIZE-65"-STANDARD PROFILE-YORK-FULL NOTCH-W/ RAIL-GLOSS BLACK
<b>67" WIDE</b>	
AA-CL-67-200-0	KING SIZE-67" STANDARD PROFILE--NO FINISH
AA-CL-67-201-0	KING SIZE-67"-STANDARD PROFILE-W/ RAIL-NO FINISH
AA-CL-67-201-1	KING SIZE-67"-STANDARD PROFILE-W/ RAIL-MATTE BLACK

AA-CL-67-201-2	KING SIZE-67"-STANDARD PROFILE-W/ RAIL GLOSS BLACK
AA-CL-67-202-0	KING SIZE-67"-STANDARD PROFILE-FULL NOTCH-NO FINISH
AA-CL-67-202-1	KING SIZE-67"-STANDARD PROFILE-FULL NOTCH-MATTE BLACK
<b>71" WIDE</b>	
AA-CL-71-200-0	STANDARD PROFILE KING SIZE-71"-NO FINISH
AA-CL-71-200-1	STANDARD PROFILE-KING SIZE-71"-MATTE BLACK
AA-CL-71-200-2	STANDARD PROFILE KING SIZE-71"-GLOSS BLACK
AA-CL-71-204-0	KING SIZE-71" STANDARD PROFILE W/ RAIL-NO FINISH

AA-CL-71-204-1	KING SIZE-71"-STANDARD PROFILE W/ RAIL-MATTE BLACK
AA-CL-71-204-2	KING SIZE-71"-STANDARD PROFILE W/ RAIL-GLOSS BLACK
AA-CL-71-224-0	KING SIZE-71"STANDARD PROFILE -UNIVERSAL NOTCH-NO FINISH
AA-CL-71-224-1	KING SIZE-71"-STANDARD PROFILE UNIVERSAL NOTCH-MATTE BLACK
AA-CL-71-224-2	KING SIZE-71"-STANDARD PROFILE UNIVERSAL NOTCH-GLOSS BLACK
AA-CL-71-225-0	KING SIZE-71"-STANDARD PROFILE UNIVERSAL NOTCH-W/ RAIL-NO FINISH
AA-CL-71-225-1	KING SIZE-71"-STANDARD PROFILE UNIVERSAL NOTCH-W/ RAIL-MATTE BLACK
AA-CL-71-225-2	KING SIZE-71"-STANDARD PROFILE UNIVERSAL NOTCH W/ RAIL-GLOSS BLACK



**Low Profile (3" off bed rail)**

LOW PROFILE KING SIZE CROSSOVER TOOLBOXES	
PRODUCT NUMBER	DESCRIPTION
<b>54" WIDE</b>	
AA-CL-54-202-1	KING SIZE-54"-LOW PROFILE-MATTE BLACK
AA-CL-54-203-0	KING SIZE-54"-LOW PROFILE-W/ RAIL-NO FINISH
AA-CL-54-203-1	KING SIZE-54"-LOW PROFILE-W/ RAIL-MATTE BLACK
AA-CL-54-204-2	KING SIZE-54"-LOW PROFILE-FULL NOTCH-GLOSS BLACK
<b>56" WIDE</b>	
AA-CL-56-200-0	KING SIZE-56"-LOW PROFILE-NO FINISH
AA-CL-56-200-2	KING SIZE-56"-LOW PROFILE-GLOSS BLACK
<b>60" WIDE</b>	
AA-CL-60-204-0	KING SIZE-60"-LOW PROFILE-NO FINISH
AA-CL-60-204-1	KING SIZE-60"-LOW PROFILE-MATTE BLACK
AA-CL-60-204-2	KING SIZE-60"-LOW PROFILE-GLOSS BLACK
AA-CL-60-205-0	KING SIZE-60"-LOW PROFILE-W/ RAIL-NO FINISH
AA-CL-60-205-1	KING SIZE-60"-LOW PROFILE-W/ RAIL-MATTE BLACK
AA-CL-60-205-2	KING SIZE-60"-LOW PROFILE-W/ RAIL-GLOSS BLACK
AA-CL-60-206-0	KING SIZE-60"-LOW PROFILE-FULL NOTCH-NO FINISH
AA-CL-60-206-1	KING SIZE-60"-LOW PROFILE-FULL NOTCH-MATTE BLACK
AA-CL-60-206-2	KING SIZE-60"-LOW PROFILE-FULL NOTCH-GLOSS BLACK
AA-CL-60-207-0	KING SIZE-60"-LOW PROFILE-FULL NOTCH-W/ RAIL-NO FINISH
AA-CL-60-207-1	KING SIZE-60"-LOW PROFILE-FULL NOTCH-W/ RAIL-MATTE BLACK
AA-CL-60-207-2	KING SIZE-60"-LOW PROFILE-FULL NOTCH-W/ RAIL-GLOSS BLACK
AA-CL-60-210-0	KING SIZE-60-YORK-LOW PROFILE-NO FINISH
AA-CL-60-210-1	KING SIZE-60-YORK--LOW PROFILE-MATTE BLACK
AA-CL-60-210-2	KING SIZE-60-YORK-LOW PROFILE-GLOSS BLACK
AA-CL-60-211-0	KING SIZE-60-YORK-LOW PROFILE-W/ RAIL-NO FINISH
AA-CL-60-211-1	KING SIZE-60-YORK-LOW PROFILE-W/ RAIL-MATTE BLACK
AA-CL-60-211-2	KING SIZE-60-YORK--LOW PROFILE-W/ RAIL-GLOSS BLACK

AA-CL-60-212-0	KING SIZE-60-YORK-LOW PROFILE-FULL NOTCH-NO FINISH
AA-CL-60-212-1	KING SIZE-60-YORK-LOW PROFILE-FULL NOTCH-MATTE BLACK
AA-CL-60-212-2	KING SIZE-60-YORK-LOW PROFILE-FULL NOTCH GLOSS BLACK
AA-CL-60-213-0	KING SIZE-60-YORK-LOW PROFILE-FULL NOTCH-W/ RAIL-NO FINISH
AA-CL-60-213-1	KING SIZE-60-YORK-LOW PROFILE-FULL NOTCH-W/ RAIL-MATTE BLACK
AA-CL-60-213-2	KING SIZE-60-YORK-LOW PROFILE-FULL NOTCH-W/ RAIL-GLOSS BLACK
<b>63" WIDE</b>	
AA-CL-63-206-0	KING SIZE-63"-LOW PROFILE-NO FINISH
AA-CL-63-206-1	KING SIZE-63"-LOW PROFILE-MATTE BLACK
AA-CL-63-206-2	KING SIZE-63"-LOW PROFILE-GLOSS BLACK
AA-CL-63-208-0	KING SIZE-63"-LOW PROFILE-W/ RAIL-NO FINISH
AA-CL-63-208-1	KING SIZE-63"-LOW PROFILE-W/ RAIL-MATTE BLACK
AA-CL-63-208-2	KING SIZE-63"-LOW PROFILE-W/ RAIL-GLOSS BLACK
AA-CL-63-209-0	KING SIZE-63"-LOW PROFILE-FULL NOTCH-NO FINISH
AA-CL-63-209-1	KING SIZE-63"-LOW PROFILE-FULL NOTCH-MATTE BLACK
AA-CL-63-209-2	KING SIZE-63"-LOW PROFILE-FULL NOTCH-GLOSS BLACK
AA-CL-63-211-0	KING SIZE-63"-LOW PROFILE-FULL NOTCH-W/ RAIL-NO FINISH
AA-CL-63-211-1	KING SIZE-63"-LOW PROFILE-FULL NOTCH-W/ RAIL-MATTE BLACK
AA-CL-63-211-2	KING SIZE-63"-LOW PROFILE-FULL NOTCH-W/ RAIL-GLOSS BLACK
<b>65" WIDE</b>	
AA-CL-65-202-0	KING SIZE-65"-LOW PROFILE-NO FINISH
AA-CL-65-202-1	KING SIZE-65"-LOW PROFILE-MATTE BLACK
AA-CL-65-202-2	KING SIZE-65"-LOW PROFILE-GLOSS BLACK
AA-CL-65-205-1	KING SIZE-65"-YORK-FULL NOTCH-LOW PROFILE-W/ RAIL-MATTE BLACK
AA-CL-65-207-0	KING SIZE-65"-YORK-LOW PROFILE-FULL NOTCH-NO FINISH
AA-CL-65-207-1	KING SIZE-65"-YORK-LOW PROFILE-FULL NOTCH-MATTE BLACK
AA-CL-65-207-2	KING SIZE-65"-YORK-LOW PROFILE-FULL NOTCH-GLOSS BLACK
AA-CL-65-208-0	KING SIZE-65"-YORK-LOW PROFILE-FULL NOTCH-W/ RAIL-NO FINISH

AA-CL-65-208-1	KING SIZE-65"-YORK-LOW PROFILE-FULL NOTCH-W/ RAIL-MATTE BLACK
AA-CL-65-208-2	KING SIZE-65"-YORK-LOW PROFILE-FULL NOTCH-W/ RAIL-GLOSS BLACK
AA-CL-65-212-0	KING SIZE 65 LOW PROFILE W/RAIL NO FINISH
AA-CL-65-212-1	KING SIZE 65 LOW PROFILE W/RAIL MATTE BLACK
AA-CL-65-212-2	KING SIZE 65 LOW PROFILE W/RAIL GLOSS BLACK
<b>67" WIDE</b>	
AA-CL-67-200-0	KING SIZE-67"-LOW PROFILE-NO FINISH
AA-CL-67-200-1	KING SIZE-67"-LOW PROFILE-MATTE BLACK
AA-CL-67-200-2	KING SIZE-67"-LOW PROFILE-GLOSS BLACK
AA-CL-67-205-0	KING SIZE-67"-LOW PROFILE-W/ RAIL-NO FINISH
AA-CL-67-205-1	KING SIZE-67"-LOW PROFILE-W/ RAIL-MATTE BLACK
AA-CL-67-205-2	KING SIZE-67"-LOW PROFILE-W/ RAIL-GLOSS BLACK
AA-CL-67-206-0	KING SIZE-67"-LOW PROFILE-FULL NOTCH-NO FINISH
AA-CL-67-206-1	KING SIZE-67"-LOW PROFILE-FULL NOTCH-MATTE BLACK
AA-CL-67-206-2	KING SIZE-67"-LOW PROFILE-FULL NOTCH-GLOSS BLACK
AA-CL-67-207-0	KING SIZE-67"-LOW PROFILE-FULL NOTCH-W/ RAIL-NO FINISH
AA-CL-67-207-1	KING SIZE-67"-LOW PROFILE-FULL NOTCH-W/ RAIL-MATTE BLACK
AA-CL-67-207-2	KING SIZE-67"-LOW PROFILE-FULL NOTCH-W/ RAIL-GLOSS BLACK

<b>69" WIDE</b>	
AA-CL-69-201-0	KING SIZE-69"-LOW PROFILE-W/ RAIL-MATTE BLACK
AA-CL-69-202-1	KING SIZE-69"-14" WIDE-LOW PROFILE-UNIVERSAL NOTCH-MATTE BLACK
<b>70" WIDE</b>	
AA-CL-70-202-0	KING SIZE-70"-LOW PROFILE-UNIVERSAL NOTCH-NO FINISH
AA-CL-70-202-1	KING SIZE-70"-LOW PROFILE-UNIVERSAL NOTCH-MATTE BLACK
AA-CL-70-202-2	KING SIZE-70"-LOW PROFILE-UNIVERSAL NOTCH-GLOSS BLACK
AA-CL-70-203-1	KING SIZE-70"-LOW PROFILE-W/ RAIL-UNIVERSAL NOTCH-MATTE BLACK
<b>71" WIDE</b>	
AA-CL-71-211-0	KING SIZE-71"-LOW PROFILE-NO FINISH
AA-CL-71-211-1	KING SIZE-71"-LOW PROFILE-MATTE BLACK
AA-CL-71-211-2	KING SIZE-71"-LOW PROFILE-GLOSS BLACK
AA-CL-71-216-0	KING SIZE-71"-LOW PROFILE-W/ RAIL-NO FINISH
AA-CL-71-216-1	KING SIZE-71"-LOW PROFILE-W/ RAIL-MATTE BLACK
AA-CL-71-216-2	KING SIZE-71"-LOW PROFILE-W/ RAIL-GLOSS BLACK
AA-CL-71-217-0	KING SIZE-71"-LOW PROFILE-UNIVERSAL NOTCH -NO FINISH
AA-CL-71-217-1	KING SIZE-71"-LOW PROFILE-UNIVERSAL NOTCH -MATTE BLACK
AA-CL-71-217-2	KING SIZE-71"-LOW PROFILE-UNIVERSAL NOTCH -GLOSS BLACK

## DEEP & TALL

### KEY FEATURES:

- Adds 4.5" to the depth, front to back, and 2" to the height, top to bottom, compared to the CamLocker standard crossover.
- The Deep & Tall adds 30% more storage compared to the standard crossover.



### Standard Profile (6" off bed rail)

DEEP & TALL CROSSOVER TOOLBOXES	
PRODUCT NUMBER	DESCRIPTION
<b>71" WIDE</b>	
AA-CL-71-107-0	STANDARD PROFILE-71"-DEEP & TALL-NO FINISH
AA-CL-71-107-1	STANDARD PROFILE-71"-DEEP & TALL-MATTE BLACK
AA-CL-71-107-2	STANDARD PROFILE-71"-DEEP & TALL-GLOSS BLACK
AA-CL-71-108-0	STANDARD PROFILE-71"-DEEP & TALL-W/ RAIL-NO FINISH
AA-CL-71-108-1	STANDARD PROFILE-71"-DEEP & TALL-W/ RAIL-MATTE BLACK
AA-CL-71-108-2	STANDARD PROFILE-71"-DEEP & TALL-W/ RAIL-GLOSS BLACK
AA-CL-71-113-0	STANDARD PROFILE-71"-DEEP & TALL-UNIVERSAL NOTCH-NO FINISH

### Low Profile (3" off bed rail)

LOW PROFILE DEEP & TALL CROSSOVER TOOLBOXES	
PRODUCT NUMBER	DESCRIPTION
<b>71" WIDE</b>	
AA-CL-71-109-0	71"-DEEP & TALL-LOW PROFILE-NO FINISH
AA-CL-71-109-1	71"-DEEP & TALL-LOW PROFILE-MATTE BLACK
AA-CL-71-109-2	71"-DEEP & TALL-LOW PROFILE-GLOSS BLACK
AA-CL-71-110-0	71"-DEEP & TALL-LOW PROFILE-W/ RAIL-NO FINISH
AA-CL-71-110-1	71"-DEEP & TALL-LOW PROFILE-W/ RAIL-MATTE BLACK
AA-CL-71-110-2	71"-DEEP & TALL-LOW PROFILE-W/ RAIL-GLOSS BLACK
AA-CL-71-111-0	71"-DEEP & TALL-LOW PROFILE-UNIVERSAL NOTCH-NO FINISH
AA-CL-71-111-1	71"-DEEP & TALL-LOW PROFILE-UNIVERSAL NOTCH-MATTE BLACK
AA-CL-71-111-2	71"-DEEP & TALL-LOW PROFILE-UNIVERSAL NOTCH-GLOSS BLACK
AA-CL-71-112-0	71"-DEEP & TALL-LOW PROFILE-UNIVERSAL NOTCH-W/ RAIL-NO FINISH
AA-CL-71-112-1	71"-DEEP & TALL-LOW PROFILE-UNIVERSAL NOTCH-W/ RAIL-MATTE BLACK
AA-CL-71-112-2	71"-DEEP & TALL-LOW PROFILE-UNIVERSAL NOTCH-W/ RAIL-GLOSS BLACK

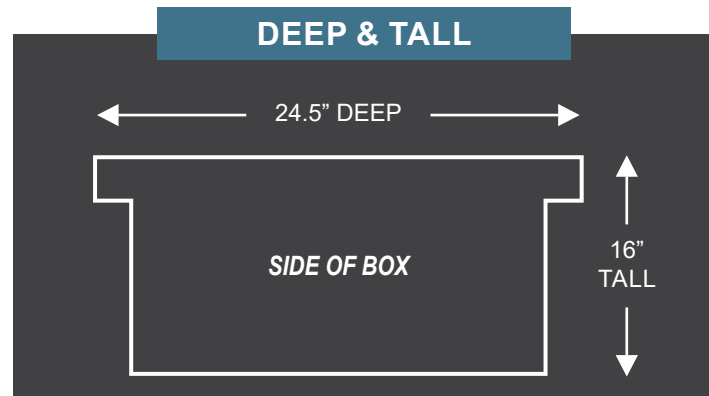
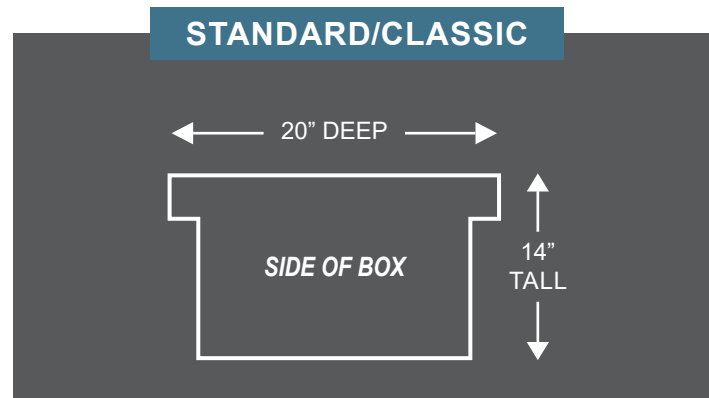

## KING SIZE XTRA DEEP & TALL

Option Available in **HD**

The Xtra Deep & Tall Measures 19" tall, top to bottom (lid included) & 24.5" deep, front to back. It is currently available in the 71 series. As the largest offering in the CamLocker line-up, the UN notching system are sure to provide the look and fit you expect from CamLocker.



### KEY FEATURES

- Adds 4.5" to the depth & 5" to the height
- Adds 40% more storage space

### Standard Profile (6" off bed rail)

KING SIZE XTRA DEEP & TALL CROSSOVER TOOLBOXES	
PRODUCT NUMBER	DESCRIPTION
<b>71" WIDE</b>	
AA-CL-71-226-0	STANDARD PROFILE KING SIZE-71"-XTRA DEEP & WIDE-NO FINISH
AA-CL-71-226-1	STANDARD PROFILE-KING SIZE-71"-XTRA DEEP & WIDE-MATTE BLACK
AA-CL-71-226-2	STANDARD PROFILE KING SIZE-71"-XTRA DEEP & WIDE-GLOSS BLACK
AA-CL-71-240-0	KING SIZE-71" STANDARD PROFILE-XTRA DEEP & WIDE-UNIVERSAL NOTCH NO FINISH
AA-CL-71-240-1	KING SIZE-71" STANDARD PROFILE-XTRA DEEP & WIDE-UNIVERSAL NOTCH-MATTE BLACK
AA-CL-71-240-2	KING SIZE-71" STANDARD PROFILE-XTRA DEEP & WIDE-UNIVERSAL NOTCH-GLOSS BLACK
AA-CL-71-243-0	KING SIZE-71"STANDARD PROFILE-XTRA DEEP & WIDE-UNIVERSAL NOTCH-W/ RAIL-NO FINISH
AA-CL-71-243-1	KING SIZE-71"STANDARD PROFILE-XTRA DEEP & WIDE-UNIVERSAL NOTCH-W/ RAIL-MATTE BLACK
AA-CL-71-243-2	KING SIZE-71"STANDARD PROFILE-XTRA DEEP & WIDE-UNIVERSAL NOTCH-W/ RAIL-GLOSS BLACK

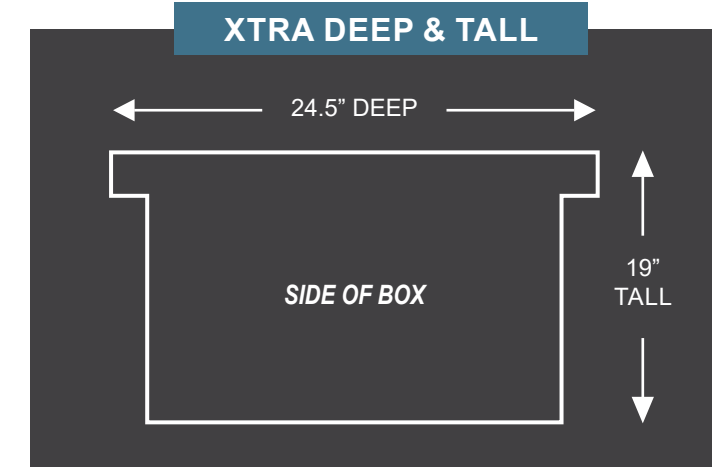
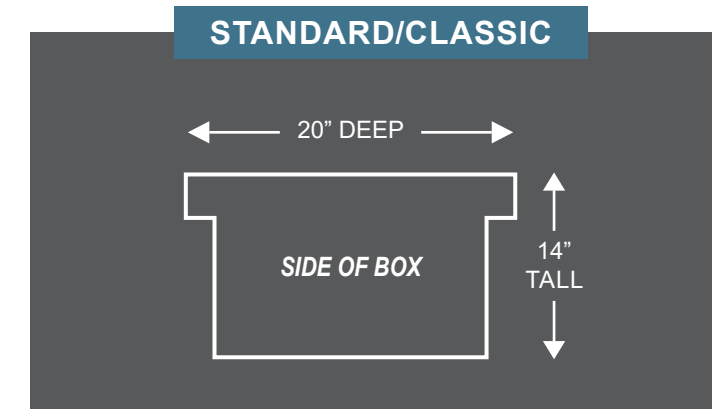



**DESIGNED FOR LAW ENFORCEMENT, AVAILABLE FOR YOU!**

- Forged from Heavy Duty .080 aluminum for the toughest jobs!
- Enhanced Weatherstripping blocking all outside elements and adding superior protection for your valuables.
- Durable, fully carpeted interior to keep your gear clean and in top shape.
- Our industry-leading locking T-handles and unique, non-duplicable key system ensure maximum security without compromise.
- Over 75 key codes are used to ensure the unlikeliness of someone having the same code.
- Key codes are hidden. All codes are stamped inside in a discreet location that only a CamLocker owner would know.
- Key blanks that only CamLocker owners have access to.

**Standard Profile (6" off bed rail)**

STANDARD/CLASSIC HD CROSSOVER TOOLBOXES	
PRODUCT NUMBER	DESCRIPTION
71" WIDE	
AA-CL-71-123-0	STANDARD PROFILE HEAVY DUTY 71 NO FINISH
AA-CL-71-123-1	STANDARD PROFILE-HEAVY DUTY-71"-MATTE BLACK
AA-CL-71-123-2	STANDARD PROFILE-HEAVY DUTY-71"-GLOSS BLACK
AA-CL-71-124-0	STANDARD PROFILE-HEAVY DUTY-71"-W/ RAIL-NO FINISH
AA-CL-71-124-1	STANDARD PROFILE-HEAVY DUTY-71"-W/ RAIL-MATTE BLACK
AA-CL-71-124-2	STANDARD PROFILE-HEAVY DUTY-71"-W/ RAIL-GLOSS BLACK

**Standard Profile (6" off bed rail)**

KING SIZE HD CROSSOVER TOOLBOXES	
PRODUCT NUMBER	DESCRIPTION
71" WIDE	
AA-CL-71-252-0	KING SIZE STANDARD PROFILE-HEAVY DUTY-71"-NO FINISH
AA-CL-71-252-1	KING SIZE STANDARD PROFILE-HEAVY DUTY-71"-MATTE BLACK
AA-CL-71-252-2	KING SIZE STANDARD PROFILE-HEAVY DUTY-71"-GLOSS BLACK
AA-CL-71-253-0	KING SIZE-HEAVY DUTY-71" STANDARD PROFILE -W/ RAIL-NO FINISH
AA-CL-71-253-1	KING SIZE-HEAVY DUTY-STANDARD PROFILE 71"-W/ RAIL-MATTE BLACK
AA-CL-71-253-2	KING SIZE-HEAVY DUTY-STANDARD PROFILE 71"-W/ RAIL-GLOSS BLACK

**KING SIZE XTRA DEEP & TALL HD CROSSOVER TOOLBOXES**

PRODUCT NUMBER	DESCRIPTION
71" WIDE	
AA-CL-71-401-0	KING SIZE-HEAVY DUTY-71" STANDARD PROFILE -EXTRA DEEP & WIDE-W/ RAIL-NO FINISH
AA-CL-71-401-1	KING SIZE-HEAVY DUTY-71" STANDARD PROFILE -EXTRA DEEP & WIDE-W/ RAIL-MATTE BLACK
AA-CL-71-401-2	KING SIZE-HEAVY DUTY-71"-STANDARD PROFILE EXTRA DEEP & WIDE-W/ RAIL-GLOSS BLACK
AA-CL-71-404-0	KING SIZE STANDARD PROFILE HEAVY DUTY 71" EXTRA DEEP & WIDE UNIVERSAL NOTCH W/ RAIL-NO FINISH
AA-CL-71-404-1	KING SIZE STANDARD PROFILE HEAVY DUTY 71" EXTRA DEEP & WIDE UNIVERSAL NOTCH W/ RAIL MATTE BLACK
AA-CL-71-404-2	KING SIZE STANDARD PROFILE HEAVY DUTY 71" EXTRA DEEP & WIDE UNIVERSAL NOTCH W/ RAIL-GLOSS BLACK

**Low Profile (3" off bed rail)**

STANDARD/CLASSIC HD CROSSOVER TOOLBOXES	
PRODUCT NUMBER	DESCRIPTION
71" WIDE	
AA-CL-71-125-0	HEAVY DUTY-71"-LOW PROFILE-NO FINISH
AA-CL-71-125-1	HEAVY DUTY-71"-LOW PROFILE-MATTE BLACK
AA-CL-71-125-2	HEAVY DUTY-71"-LOW PROFILE-GLOSS BLACK
AA-CL-71-126-0	HEAVY DUTY-71"-LOW PROFILE-W/ RAIL-NO FINISH
AA-CL-71-126-1	HEAVY DUTY-71"-LOW PROFILE-W/ RAIL-MATTE BLACK
AA-CL-71-126-2	HEAVY DUTY-71"-LOW PROFILE-W/ RAIL-GLOSS BLACK

AA-CL-71-255-2	KING SIZE-HEAVY DUTY-71"-LOW PROFILE-GLOSS BLACK
AA-CL-71-256-0	KING SIZE-HEAVY DUTY-71"-LOW PROFILE-W/ RAIL-NO FINISH
AA-CL-71-256-1	KING SIZE-HEAVY DUTY-71"-LOW PROFILE-W/ RAIL-MATTE BLACK
AA-CL-71-256-2	KING SIZE-HEAVY DUTY-71"-LOW PROFILE-W/ RAIL-GLOSS BLACK
AA-CL-71-257-0	KING SIZE HEAVY DUTY 71" LOW PROFILE UNIVERSAL NOTCH W/ RAIL
AA-CL-71-257-1	KING SIZE HEAVY DUTY 71" LOW PROFILE UNIVERSAL NOTCH W/ RAIL MATTE BLACK
AA-CL-71-257-2	KING SIZE HEAVY DUTY 71" LOW PROFILE UNIVERSAL NOTCH W/ RAIL GLOSS BLACK

**KING SIZE HD CROSSOVER TOOLBOXES**

PRODUCT NUMBER	DESCRIPTION
63" WIDE	
AA-CL-63-217-0	KING SIZE 63 HD LOW PROFILE FULL NOTCH NO FINISH
AA-CL-63-217-1	KING SIZE 63 HD LOW PROFILE FULL NOTCH MATTE BLACK
AA-CL-63-217-2	KING SIZE 63 HD LOW PROFILE FULL NOTCH GLOSS BLACK
71" WIDE	
AA-CL-71-255-0	KING SIZE-HEAVY DUTY-71"-LOW PROFILE-NO FINISH
AA-CL-71-255-1	KING SIZE- HEAVY DUTY-71"-LOW PROFILE-MATTE BLACK

**KING SIZE XTRA DEEP & TALL HD CROSSOVER TOOLBOXES**

PRODUCT NUMBER	DESCRIPTION
71" WIDE	
AA-CL-71-402-0	KING SIZE-HEAVY DUTY-71"-EXTRA DEEP & WIDE-LOW PROFILE-NO FINISH
AA-CL-71-402-1	KING SIZE-HEAVY DUTY-71"-EXTRA DEEP & WIDE-LOW PROFILE-MATTE BLACK
AA-CL-71-402-2	KING SIZE-HEAVY DUTY-71"-EXTRA DEEP & WIDE-LOW PROFILE-GLOSS BLACK
AA-CL-71-403-0	KING SIZE-HEAVY DUTY-71"-EXTRA DEEP & WIDE-LOW PROFILE-W/ RAIL-NO FINISH
AA-CL-71-403-1	KING SIZE-HEAVY DUTY-71"-EXTRA DEEP & WIDE-LOW PROFILE-W/ RAIL-MATTE BLACK
AA-CL-71-403-2	KING SIZE-HEAVY DUTY-71"-EXTRA DEEP & WIDE-LOW PROFILE-W/ RAIL-GLOSS BLACK



## RECREATIONAL VEHICLE "RV" BOX

Great for use as an in-bed toolbox if you prefer it not to sit on the rails but finish with more of a flush look.

The RV box can be used as a dock-box for use by the water or as the name suggests in the cargo hold in your RV. The RV series originally got its start at AAA, Inc. and CamLocker as a tack box in the horse and livestock markets.

- Bevel = 4" x 4" 45° angle in bottom left and right hand corners. Recommended for use in truck beds. Available on all models except the 36.
- Full Notch = up step/stair shape notch in bottom left and right hand corners to accommodate for wheel wells. Available on 53's.
- Super Crew Notch = To accommodate wheel wells. Available on 57's & 60's.

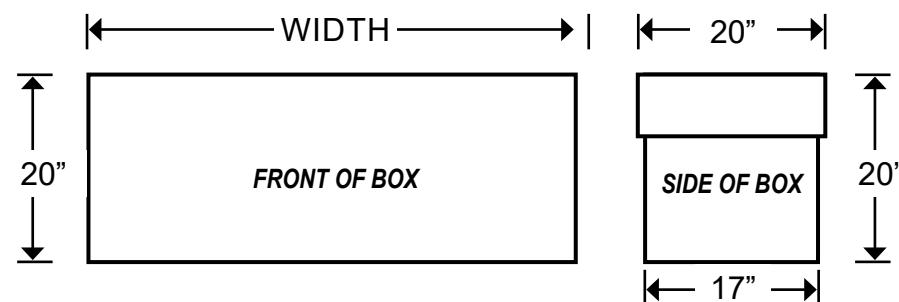

### KEY FEATURES

- Measures 20" x 20" for the Height and Depth
- Available widths 36", 48", 53", 57" & 60".
- Dual-locking handles for additional storage
- Lid self opens 90°

RV BOXES	
PRODUCT NUMBER	DESCRIPTION
<b>36" WIDE</b>	
AA-CL-36-700-0	RV-36"-NO FINISH
AA-CL-36-700-1	RV-36"-MATTE BLACK
AA-CL-36-700-2	RV-36"-GLOSS BLACK
AA-CL-36-701-0	RV-36"-W/ RAIL-NO FINISH
AA-CL-36-701-1	RV-36"-W/ RAIL-MATTE BLACK
AA-CL-36-701-2	RV-36"-W/ RAIL-GLOSS BLACK
<b>48" WIDE</b>	
AA-CL-48-700-0	RV-48"-NO FINISH
AA-CL-48-700-1	RV-48"-MATTE BLACK
AA-CL-48-700-2	RV-48"-GLOSS BLACK
AA-CL-48-701-0	RV-48"-W/ RAIL-NO FINISH
AA-CL-48-701-1	RV-48"-W/ RAIL-MATTE BLACK
AA-CL-48-701-2	RV-48"-W/ RAIL-GLOSS BLACK
AA-CL-48-702-0	RV-48"-W/ BEVEL-NO FINISH
AA-CL-48-702-1	RV-48"-W/ BEVEL-MATTE BLACK
AA-CL-48-702-2	RV-48"-W/ BEVEL-GLOSS BLACK
AA-CL-48-703-0	RV-48"-W/ BEVEL-W/ RAIL-NO FINISH
AA-CL-48-703-1	RV-48"-W/ BEVEL-W/ RAIL-MATTE BLACK
AA-CL-48-703-2	RV-48"-W/ BEVEL-W/ RAIL-GLOSS BLACK
<b>53" WIDE</b>	
AA-CL-53-700-0	RV-53"-NO FINISH
AA-CL-53-700-1	RV-53"-MATTE BLACK
AA-CL-53-700-2	RV-53"-GLOSS BLACK
AA-CL-53-701-0	RV-53"-W/ RAIL-NO FINISH
AA-CL-53-701-1	RV-53"-W/ RAIL-MATTE BLACK
AA-CL-53-701-2	RV-53"-W/ RAIL-GLOSS BLACK
AA-CL-53-702-0	RV-53"-W/ BEVEL-NO FINISH
AA-CL-53-702-1	RV-53"-W/ BEVEL-MATTE BLACK
AA-CL-53-702-2	RV-53"-W/ BEVEL-GLOSS BLACK
AA-CL-53-703-0	RV-53"-W/ BEVEL-W/ RAIL-NO FINISH
AA-CL-53-703-1	RV-53"-W/ BEVEL-W/ RAIL-MATTE BLACK
AA-CL-53-703-2	RV-53"-W/ BEVEL-W/ RAIL-GLOSS BLACK
AA-CL-53-704-0	RV-53"-FULL NOTCH-NO FINISH
AA-CL-53-704-1	RV-53"-FULL NOTCH-MATTE BLACK
AA-CL-53-704-2	RV-53"-FULL NOTCH-GLOSS BLACK
AA-CL-53-705-0	RV-53"-FULL NOTCH-W/ RAIL-NO FINISH
AA-CL-53-705-1	RV-53"-FULL NOTCH-W/ RAIL-MATTE BLACK
AA-CL-53-705-2	RV-53"-FULL NOTCH-W/ RAIL-GLOSS BLACK
AA-CL-53-708-0	RV-53"-SUPER CREW NOTCH-NO FINISH
AA-CL-53-708-1	RV-53"-SUPER CREW NOTCH-MATTE BLACK
AA-CL-53-708-2	RV-53"-SUPER CREW NOTCH-GLOSS BLACK

54" WIDE	
AA-CL-54-700-0	RV-54"-NO FINISH
<b>57" WIDE</b>	
AA-CL-57-700-0	RV-57"-NO FINISH
AA-CL-57-700-1	RV-57"-MATTE BLACK
AA-CL-57-700-2	RV-57"-GLOSS BLACK
AA-CL-57-701-0	RV-57"-W/ RAIL-NO FINISH
AA-CL-57-701-1	RV-57"-W/ RAIL-MATTE BLACK
AA-CL-57-701-2	RV-57"-W/ RAIL-GLOSS BLACK
AA-CL-57-702-0	RV-57"-W/ BEVEL-NO FINISH
AA-CL-57-702-1	RV-57"-W/ BEVEL-MATTE BLACK
AA-CL-57-702-2	RV-57"-W/ BEVEL-GLOSS BLACK
AA-CL-57-703-0	RV-57"-W/ BEVEL-W/ RAIL-NO FINISH
AA-CL-57-703-1	RV-57"-W/ BEVEL-W/ RAIL-MATTE BLACK
AA-CL-57-703-2	RV-57"-W/ BEVEL-W/ RAIL-GLOSS BLACK
AA-CL-57-704-0	RV-57"-SUPER CREW NOTCH-W/ RAIL-NO FINISH
AA-CL-57-704-1	RV-57"-SUPER CREW NOTCH-W/ RAIL-MATTEBLACK
AA-CL-57-704-2	RV-57"-SUPER CREW NOTCH-W/ RAIL-GLOSS BLACK
AA-CL-57-705-0	RV-57"-UNIVERSAL NOTCH-NO FINISH
AA-CL-57-706-0	RV 57" SUPER CREW NOTCH NO FINISH
AA-CL-57-706-1	RV 57" SUPER CREW NOTCH MATTE BLACK
AA-CL-57-706-2	RV 57" SUPER CREW NOTCH GLOSS BLACK
<b>60" WIDE</b>	
AA-CL-60-700-0	RV-60"-NO FINISH
AA-CL-60-700-1	RV-60"-MATTE BLACK
AA-CL-60-700-2	RV-60"-GLOSS BLACK
AA-CL-60-701-0	RV-60"-W/ RAIL-NO FINISH
AA-CL-60-701-1	RV-60"-W/ RAIL-MATTE BLACK
AA-CL-60-701-2	RV-60"-W/ RAIL-GLOSS BLACK
AA-CL-60-702-0	RV-60"-W/ BEVEL-NO FINISH
AA-CL-60-702-1	RV-60"-W/ BEVEL-MATTE BLACK
AA-CL-60-702-2	RV-60"-W/ BEVEL-GLOSS BLACK
AA-CL-60-703-0	RV-60"-W/ BEVEL-W/ RAIL-NO FINISH
AA-CL-60-703-1	RV-60"-W/ BEVEL-W/ RAIL-MATTE BLACK
AA-CL-60-703-2	RV-60"-W/ BEVEL-W/ RAIL-GLOSS BLACK
AA-CL-60-704-0	RV-60"-SUPER CREW NOTCH-NO FINISH
AA-CL-60-704-1	RV-60"-SUPER CREW NOTCH-MATTE BLACK
AA-CL-60-704-2	RV-60"-SUPER CREW NOTCH-GLOSS BLACK
AA-CL-60-714-0	RV 60 SUPER CREW NOTCH W/RAIL NO FINISH
AA-CL-60-714-1	RV 60 SUPER CREW NOTCH W/RAIL MATTE BLA
AA-CL-60-714-2	RV60 SUPER CREW NOTCH W/RAIL GLOSS BLACK



## SIDEMOUNT BOXES

12" Deep (front to back), 12" Tall (top to bottom)

### PRODUCT DETAILS

- Offering sidemount toolboxes in standard or low-profile for more visual
- Mounts on the inside of the truck bed for additional truck bed space
- Locking t-handles for additional storage



### Standard Profile (Handles on Front)

SIDEMOUNT BOXES	
PRODUCT NUMBER	DESCRIPTION
<b>30" WIDE</b>	
AA-CL-30-600-1	SIDE MOUNT BOX-30"-MATTE BLACK
<b>36" WIDE</b>	
AA-CL-36-600-0	STANDARD PROFILE SIDE MOUNT BOX-36"-NO FINISH
AA-CL-36-600-1	STANDARD PROFILE SIDE MOUNT BOX-36"-MATTE BLACK
AA-CL-36-600-2	STANDARD PROFILE SIDE MOUNT BOX-36"-GLOSS BLACK
AA-CL-36-601-0	STANDARD PROFILE SIDE MOUNT BOX-36"-W/ RAIL-NO FINISH
AA-CL-36-601-1	STANDARD PROFILE SIDE MOUNT BOX-36"-W/ RAIL-MATTE BLACK
AA-CL-36-601-2	STANDARD PROFILE SIDE MOUNT BOX-36"-W/ RAIL-GLOSS BLACK
<b>48" WIDE</b>	
AA-CL-48-600-0	SIDE MOUNT BOX-48"-NO FINISH
AA-CL-48-600-1	SIDE MOUNT BOX-48"-MATTE BLACK
AA-CL-48-600-2	SIDE MOUNT BOX-48"-GLOSS BLACK

AA-CL-48-601-0	SIDE MOUNT BOX-48"-W/ RAIL-NO FINISH
AA-CL-48-601-1	SIDE MOUNT BOX-48"-W/ RAIL-MATTE BLACK
AA-CL-48-601-2	SIDE MOUNT BOX-48"-W/ RAIL-GLOSS BLACK
<b>58" WIDE</b>	
AA-CL-58-600-0	SIDE MOUNT BOX-58"-NO FINISH
AA-CL-58-600-1	SIDE MOUNT BOX-58"-MATTE BLACK
AA-CL-58-600-2	SIDE MOUNT BOX-58"-GLOSS BLACK
AA-CL-58-601-0	SIDE MOUNT BOX-58"-W/ RAIL-NO FINISH
AA-CL-58-601-1	SIDE MOUNT BOX-58"-W/ RAIL-MATTE BLACK
AA-CL-58-601-2	SIDE MOUNT BOX-58"-W/ RAIL-GLOSS BLACK
<b>60" WIDE</b>	
AA-CL-60-600-0	SIDE MOUNT BOX-60"-NO FINISH
AA-CL-60-600-1	SIDE MOUNT BOX-60"-MATTE BLACK
AA-CL-60-600-2	SIDE MOUNT BOX-60"-GLOSS BLACK
AA-CL-60-601-0	SIDE MOUNT BOX-60"-W/ RAIL-NO FINISH
AA-CL-60-601-1	SIDE MOUNT BOX-60"-W/ RAIL-MATTE BLACK
AA-CL-60-601-2	SIDE MOUNT BOX-60"-W/ RAIL-GLOSS BLACK
<b>68" WIDE</b>	
AA-CL-68-600-0	SIDE MOUNT BOX-68"-NO FINISH
AA-CL-68-600-1	SIDE MOUNT BOX-68"-MATTE BLACK
AA-CL-68-600-2	SIDE MOUNT BOX-68"-GLOSS BLACK
AA-CL-68-601-0	SIDE MOUNT BOX-68"-W/ RAIL-NO FINISH
AA-CL-68-601-1	SIDE MOUNT BOX-68"-W/ RAIL-MATTE BLACK
AA-CL-68-601-2	SIDE MOUNT BOX-68"-W/ RAIL-GLOSS BLACK
<b>72" WIDE</b>	
AA-CL-72-600-0	SIDE MOUNT BOX-72"-NO FINISH
AA-CL-72-600-1	SIDE MOUNT BOX-72"-MATTE BLACK
AA-CL-72-600-2	SIDE MOUNT BOX-72"-GLOSS BLACK
AA-CL-72-601-0	SIDE MOUNT BOX-72"-STANDARD PROFILE W/ RAIL-NO FINISH
AA-CL-72-601-1	SIDE MOUNT BOX-72"-STANDARD PROFILE W/ RAIL-MATTE BLACK
AA-CL-72-601-2	SIDE MOUNT BOX-72"-STANDARD PROFILE W/ RAIL-GLOSS BLACK

### Low Profile (Handles on Sides)

SIDEMOUNT BOXES	
PRODUCT NUMBER	DESCRIPTION
<b>36" WIDE</b>	
AA-CL-36-603-0	SIDE MOUNT BOX-36"-LOW PROFILE-NO FINISH
AA-CL-36-603-1	SIDE MOUNT BOX-36"-LOW PROFILE-MATTE BLACK
AA-CL-36-603-2	SIDE MOUNT BOX-36"-LOW PROFILE-GLOSS BLACK
AA-CL-36-604-1	SIDE MOUNT BOX-36"-LOW PROFILE-W/ RAIL-MATTE BLACK
AA-CL-36-604-2	SIDE MOUNT BOX-36"-LOW PROFILE-W/ RAIL-GLOSS BLACK
<b>48" WIDE</b>	
AA-CL-48-603-0	SIDE MOUNT BOX-48"-LOW PROFILE-NO FINISH
AA-CL-48-603-1	SIDE MOUNT BOX-48"-LOW PROFILE-MATTE BLACK
AA-CL-48-603-2	SIDE MOUNT BOX-48"-LOW PROFILE-GLOSS BLACK
<b>60" WIDE</b>	
AA-CL-60-602-0	SIDE MOUNT BOX-60"-LOW PROFILE-NO FINISH
AA-CL-60-602-1	SIDE MOUNT BOX-60"-LOW PROFILE-MATTE BLACK
AA-CL-60-602-2	SIDE MOUNT BOX-60"-LOW PROFILE-GLOSS BLACK
AA-CL-60-603-0	SIDE MOUNT BOX-60"-LOW PROFILE-W/ RAIL-NO FINISH
AA-CL-60-603-1	SIDE MOUNT BOX-60"-LOW PROFILE-W/ RAIL-MATTE BLACK
AA-CL-60-603-2	SIDE MOUNT BOX-60"-LOW PROFILE-W/ RAIL-GLOSS BLACK
<b>68" WIDE</b>	
AA-CL-68-602-0	SIDE MOUNT BOX-68"-LOW PROFILE-NO FINISH
AA-CL-68-602-1	SIDE MOUNT BOX-68"-LOW PROFILE-MATTE BLACK
AA-CL-68-602-2	SIDE MOUNT BOX-68"-LOW PROFILE-GLOSS BLACK
<b>72" WIDE</b>	
AA-CL-72-602-0	SIDE MOUNT BOX-72"-LOW PROFILE-NO FINISH
AA-CL-72-602-1	SIDE MOUNT BOX-72"-LOW PROFILE-MATTE BLACK
AA-CL-72-604-1	SIDE MOUNT BOX-72"-LOW PROFILE-W/ RAIL-MATTE BLACK

## SXS (UTV) BOXES

**12" Deep** (front to back), **12" Tall** (top to bottom)

Ride with the ease of knowing your items are safe and secure.

### TOOLBOXES AVAILABLE FOR:

- Can-AM Defender
- Polaris Ranger
- Polaris Razor
- Polaris General XP 1000
- Yamaha Viking
- Honda Pioneer 1000
- John Deere Gator
- Kawasaki Mule Pro- FXT

### PRODUCT DETAILS

- Built to keep luggage or tools secure while riding outdoors
- Built with our Camlocker locking stainless steel locks for security
- Easy opening access on both sides
- Tight seal to keep dust and dirt out

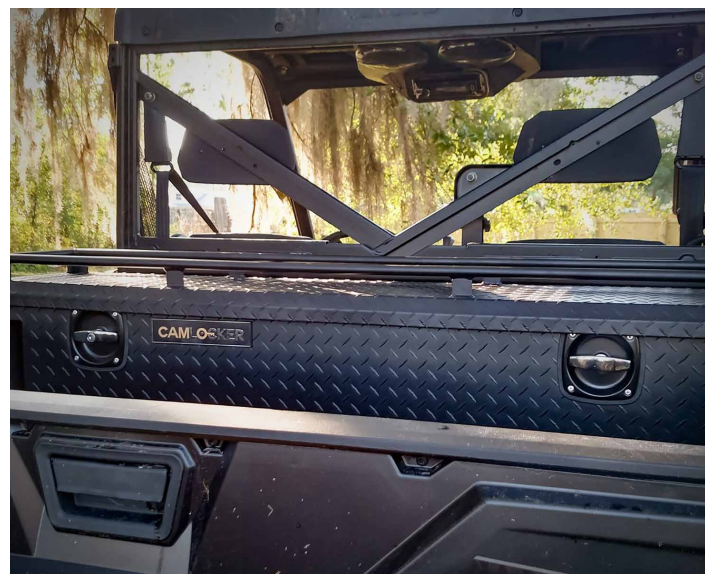

### Standard Profile (6" off bed rail, handles on side)

SXS (UTV) BOXES	
PRODUCT NUMBER	DESCRIPTION
AA-CL-00-804-0	SxS-NO FINISH
AA-CL-00-804-1	SXS- STANDARD PROFILE MATTE BLACK
AA-CL-00-804-2	SXS-GLOSS BLACK
AA-CL-00-807-1	SXS POLARIS GENERAL STANDARD PROFILE - MATTE BLACK
AA-CL-00-812-0	SXS-W/ RAIL-NO FINISH
AA-CL-00-812-1	SXS-W/ RAIL-MATTE BLACK
AA-CL-00-812-2	STANDARD PROFILE SXS-W/ RAIL-GLOSS BLACK
AA-CL-00-813-0	SXS-25"-RZR-NO FINISH
AA-CL-00-813-1	SXS-25"-POLARIS RZR-MATTE BLACK
AA-CL-00-813-2	SXS-25"-RZR-GLOSS BLACK
AA-CL-00-815-0	SXS-44"-MAVERICK X3-NO FINISH
AA-CL-00-815-1	SXS-44"-MAVERICK X3-MATTE BLACK
AA-CL-00-815-2	SXS-44"-MAVERICK X3-GLOSS BLACK
AA-CL-00-818-0	SXS-63"-NO FINISH
AA-CL-00-818-1	SXS-63"-MATTE BLACK
AA-CL-00-818-2	SXS-63"-GLOSS BLACK

### Side Mount Boxes

SXS (UTV) SIDE MOUNT BOXES	
PRODUCT NUMBER	DESCRIPTION
AA-CL-00-801-0	SXS SMB 18" SHORT NO FINISH
AA-CL-00-801-1	SXS SMB 18" SHORT MATTE BLACK
AA-CL-00-801-2	SXS SMB 18" SHORT GLOSS BLACK
AA-CL-00-803-0	SXS SMB 33" NO FINISH
AA-CL-00-803-1	SXS SMB 33" MATTE BLACK
AA-CL-00-803-2	SXS SMB 33" GLOSS BLACK
AA-CL-00-851-0	SXS SMB 18" SHORT W/RAIL NO FINISH
AA-CL-00-851-1	SXS SMB 18" SHORT W/RAIL MATTE BLACK
AA-CL-00-851-2	SXS SMB 18" SHORT W/RAIL GLOSS BLACK
AA-CL-00-853-0	SXS SMB 33" W/RAIL NO FINISH
AA-CL-00-853-1	SXS SMB 33" W/RAIL MATTE BLACK
AA-CL-00-853-2	SXS SMB 33" W/RAIL GLOSS BLACK

### Low Profile (3" off bed rail, handles on front)

SXS (UTV) BOXES	
PRODUCT NUMBER	DESCRIPTION
AA-CL-00-805-0	SXS-54"-LOW PROFILE-POLARIS GENERAL-NO FINISH
AA-CL-00-805-1	SXS-54"-LOW PROFILE-POLARIS GENERAL-MATTE BLACK
AA-CL-00-805-2	SXS-54"-LOW PROFILE-POLARIS GENERAL GLOSS BLACK
AA-CL-00-806-1	SXS-54"-LOW PROFILE-POLARIS GENERAL-W/ RAIL-MATTE BLACK
AA-CL-00-808-1	SXS-51"-LOW PROFILE-JOHN DEERE-MATTE BLACK
AA-CL-00-809-1	SXS-51"-LOW PROFILE-JOHN DEERE-W/ RAIL-MATTE BLACK
AA-CL-00-810-1	SXS-57"-LOW PROFILE-JOHN DEERE-MATTE BLACK
AA-CL-00-811-1	SXS-57"-LOW PROFILE-JOHN DEERE-W/ RAIL-MATTE BLACK
AA-CL-00-816-1	SXS-54"-LOW PROFILE-MATTE BLACK
AA-CL-00-817-1	SXS-62"-LOW PROFILE-W/ RAIL-MATTE BLACK
AA-CL-00-819-0	SXS-63"-LOW PROFILE NO FINISH
AA-CL-00-819-1	SXS-63"-LOW PROFILE-MATTE BLACK
AA-CL-00-819-2	SXS-63"-LOW PROFILE GLOSS BLACK
AA-CL-00-820-0	SXS-63"-LOW PROFILE W/ RAIL
AA-CL-00-820-1	SXS-63"-LOW PROFILE-W/ RAIL-MATTE BLACK
AA-CL-00-820-2	SXS-63"-LOW PROFILE-W/ RAIL-GLOSS BLACK
AA-CL-00-821-0	SXS-LOW PROFILE-NO FINISH
AA-CL-00-821-1	SXS-LOW PROFILE-MATTE BLACK
AA-CL-00-821-2	SXS-LOW PROFILE-GLOSS BLACK
AA-CL-00-822-0	SXS-LOW PROFILE-HIGH LIFTER 2 DOOR-NO FINISH
AA-CL-00-822-1	SXS-LOW PROFILE-HIGH LIFTER 2 DOOR-MATTE BLACK
AA-CL-00-822-2	SXS-LOW PROFILE-HIGH LIFTER 2 DOOR-GLOSS BLACK
AA-CL-00-823-0	SXS-LOW PROFILE-W/ RAIL-NO FINISH
AA-CL-00-823-1	SXS-LOW PROFILE-W/ RAIL-MATTE BLACK
AA-CL-00-823-2	SXS-LOW PROFILE-W/ RAIL-GLOSS BLACK

## CAMLOCKER SIDE MOUNT TOOLBOX & UNDERBODY BOX



## HUNTING ACCESSORIES

All products offered in Aluminum or Matte Black Powder Coat



**DOGBOXES**  
(with accessories for additional pricing)

- 48x34x24
- 48x48x24



**Water Tanks:**

- 6" x 6" x 36"
- 6" x 6" x 48"

**Collar Boxes:**

- 20" x 20" x 7"
- 30" x 32" x 7"

**Cooler Rack + One Gallon Spill-proof Water Dish**

# CAMLOCKER CROSSOVER: MAKE & MODEL FIT GUIDE

Vehicle Make/ Model/ Year/ Bed Length	Slimline Standard Profile		Slimline Low Profile		Classic Standard Profile		Classic Low Profile		King Size Standard Profile		King Size Low Profile		XDT Standard Profile	XDT Low Profile											
	AA-CL-60-503-X	AA-CL-63-500-X	AA-CL-71-500-X	AA-CL-60-505-X	AA-CL-63-504-X	AA-CL-71-503-X	AA-CL-60-100-X	AA-CL-63-100-X	AA-CL-63-107-X	AA-CL-71-100-X	AA-CL-60-111-X	AA-CL-63-109-X	AA-CL-63-112-X	AA-CL-71-115-X	AA-CL-60-202-X	AA-CL-63-204-X	AA-CL-71-200-X	AA-CL-71-224-X	AA-CL-60-206-X	AA-CL-63-209-X	AA-CL-71-211-X	AA-CL-71-217-X	AA-CL-71-240-X	AA-CL-71-233-X	
Chevrolet Colorado/ GMC Canyon '15-'22	✓			✓			✓							✓											
Chevrolet Colorado/ GMC Canyon '04-'12 & '23-'25	✓			✓			✓				✓				✓										
Chevrolet 1500 5.5' Bed			✓			✓			✓				✓									✓	✓	✓	✓
Chevrolet 2500, 3500 6.5' Bed			✓			✓			✓				✓									✓	✓	✓	✓
Ford F-150 5.5' Bed			✓			✓			✓				✓									✓	✓	✓	✓
Ford F-250, F-350 6.5' Bed			✓			✓			✓				✓									✓	✓	✓	✓
Dodge Ram 1500 5.5' Bed			✓			✓			✓				✓									✓	✓	✓	✓
Dodge Ram 2500, 3500 6.5' Bed			✓			✓			✓				✓									✓	✓	✓	✓
Toyota Tundra '07-Current			✓			✓			✓				✓									✓	✓	✓	✓
Toyota Tacoma '05- Current	✓			✓			✓		✓				✓												
Nissan Frontier '05- Current	✓			✓			✓		✓				✓												

- Slimline**
- 14" Deep, 11" Tall
- Classic**
- 20" Deep, 14" Tall

- King Size**
- 20" Deep, 19" Tall
- XDТ (Xtra Deep & Tall)**
- 24.5" Deep, 19" Tall

**Available Ordering Options:** Add suffix to end of part number (-X) for desired color option.

- -0 (No Finish)
- -1 (Matte Black)
- -2 (Gloss Black)



CamLocker - LIMITED LIFETIME WARRANTY. REGISTER ONLINE AT [www.CamLockerOnline.com](http://www.CamLockerOnline.com). Registering will activate the Limited Lifetime Warranty. You may also call or mail your warranty in to complete the registration process. Failure to register your product within 14 days of the date of purchase listed on your receipt will result in loss of coverage as detailed below. Limited Lifetime Warranty American Aluminum Accessories, Inc. (manufacturer) guarantees a limited lifetime warranty of materials and workmanship of the equipment due to normal use. The Limited Lifetime warranty remains in effect and applies to the original purchaser ("purchaser") of a new product. A new product is defined as Newly Installed CamLocker Toolbox. The warranty lasts for as long as the original purchaser owns the vehicle on which the product was originally installed. The warranty is not transferable from purchaser to any subsequent owner and/or vehicles. The warranty immediately terminates if product is removed from the original vehicle or if vehicle transfers ownership. Modification of any kind voids all warranty coverage. Warranty is limited to replacement or repair of genuine American Aluminum Accessories, Inc. products. \*\*See Bottom Conditionally Covered Items Wear and operational items such as shocks, latches, hinges, hardware, gaskets, keys, lift-cylinders, etc...are covered for 3 years/36 months from date of purchase on receipt. Replacements can be ordered via credit card by calling 1-800-277-0869. Powder coating carries a 1 year or 12 months from date of purchase warranty. Coverage extends through both currently available options of matte & gloss black. The high quality finish must be cared for and maintained like any other exposed finish. Protect the finish with non-abrasive auto-wash on a regular basis. Compounds with abrasive materials may scratch the finish and leave exposed areas susceptible to blemishing. All Warranty Claims must be initiated at the place of purchase. Original receipt proof of purchase, displaying the date and registered warranty must accompany all claims along with photographs referencing defect. What is not covered: Buyer assumes all risk, liability, cost for installation and use of American Aluminum Accessories, Inc. products. All products are sold functionally as lifestyle products for work and play are not relied upon as protection for the vehicle or its occupants in the event of an accident. The warranty does not cover re-installation, cost of removal, labor, transportation costs, loss of use, inconvenience or consequential damages. Warranty excludes damage resulting from misuse, abuse, accident, improper installation (when not installed by American Aluminum Technicians), modification of any kind, vandalism, spills, improper or inadequate maintenance or on-road and off-road hazards to the original purchaser.

\*\*THIS LIMITED WARRANTY DOES NOT COVER LABOR COSTS or incidental, indirect, special or consequential damages such as, but not limited to, physical injuries or property damage, loss of time, loss of use of the vehicle, inconvenience, rental vehicle charges, towing charges or accommodations resulting from a defect in or failure of the part. This limited warranty represents the exclusive remedy for any product defect or failure and the total liability of American Aluminum Accessories, Inc., and its subsidiaries and affiliates ("AAA") for any part it warrants. AAA MAKES NO OTHER WARRANTIES, EXPRESS OR IMPLIED, INCLUDING ANY WARRANTIES OF MERCHANTABILITY, CONDITION OF ANY KIND OR FITNESS FOR A PARTICULAR PURPOSE. Some states do not allow disclaimers of implied warranties. Therefore all implied warranties that may apply to your purchase are limited to the duration of this written warranty. Some states also do not allow limitations on how long an implied warranty lasts or the exclusion or limitation of incidental, special or consequential damages, so the above information may not apply to you. This warranty gives you specific rights, and you may have other rights which vary from state to state. AAA does not authorize any person to vary the terms, conditions or exclusions of this warranty. If any provision of the warranty should become invalid or unenforceable because of any laws, the remaining terms and provisions of the warranty shall remain in full force and effect. To the extent allowed under local law, the remedies provided in this Limited Warranty Policy are the customer's sole and exclusive remedies.



**WE ARE PROUD TO SERVE YOU WITH  
AMERICAN HAND-CRAFTED PRODUCTS!**

Located in Perry, Florida

**CamLocker Toolboxes**  
3382 US HWY 19 South  
Perry, Florida 32348

**American Aluminum Accessories, LLC**  
3291 US HWY 19 South  
Perry, Florida 32348



## EMPLOYEE DIRECTORY

<b>Jennifer Arnold</b>	General Manager	Jennifer.Arnold@aaa-mail.com
<b>Marisol Swain</b>	Director of Operations	Marisol.Swain@aaa-mail.com
<b>Matthew Eastman</b>	CamLocker Legacy Sales	Matthew.Eastman@aaa-mail.com
<b>Courtney Hatch</b>	Marketing Coordinator	Courtney.Hatch@aaa-mail.com
<b>Johnathan Murphy</b>	Sales and Product Support Technician	Johnathan.Murphy@aaa-mail.com
<b>Eric Lauritzen</b>	Engineer Manager	Eric.Lauritzen@aaa-mail.com
<b>Jennifer Eakins</b>	Customer Service Representative	Jennifer.Eakins@aaa-mail.com
<b>Kyle Bailey</b>	Customer Service Representative	Kyle.Bailey@aaa-mail.com
<b>Katrina Turner</b>	Customer Service Representative	Katrina.Turner@aaa-mail.com
<b>Brandy Williams</b>	Accounting Specialist	Brandy.Williams@aaa-mail.com
<b>Kimberely Streetman</b>	Customer Service Representative	Kimberely.Streetman@aaa-mail.com
<b>Megan Tucker</b>	Customer Service Representative	Megan.Tucker@aaa-mail.com



**AMERICAN<sup>TM</sup>  
ALUMINUM**  
ACCESSORIES, LLC.

a **TEAMGJ** brand